

GODIAG GT106 24V TO 12V OBD2 Scanner For Heavy Duty Truck Adapter



User Manual

2.2023

Product overview

GODIAG GT106 24V TO 12V OBD2 Scanner For Heavy Duty Truck Adapter is a dedicated connection adapter developed for truck or car maintenance technicians, DIY maintenance personnel. The product can convert the 24V power of the truck diagnostic interface into DC12.5V, so that the 12V diagnostic equipment with truck diagnostic software can diagnose the truck and heavy-duty vehicles. This product can protect 12V diagnostic equipment and convert the 24V K-line signal of the truck into a 12V K-line signal, thereby protecting the 7PIN K-Line communication of the 12V diagnostic equipment from being burned by 24V. Switch the input and output display to display the current 24V voltage input of the truck diagnostic interface and the converted output voltage. The device has a power indicator, J1939 (PIN12), CANH/J1939 (PIN6), J1708 K-line (PIN7) signal communication indicators, and the corresponding protocol indicator will flash when there is data communication. The communication status can be judged, and it can also be judged whether the diagnostic programming device can communicate.

Product Structure

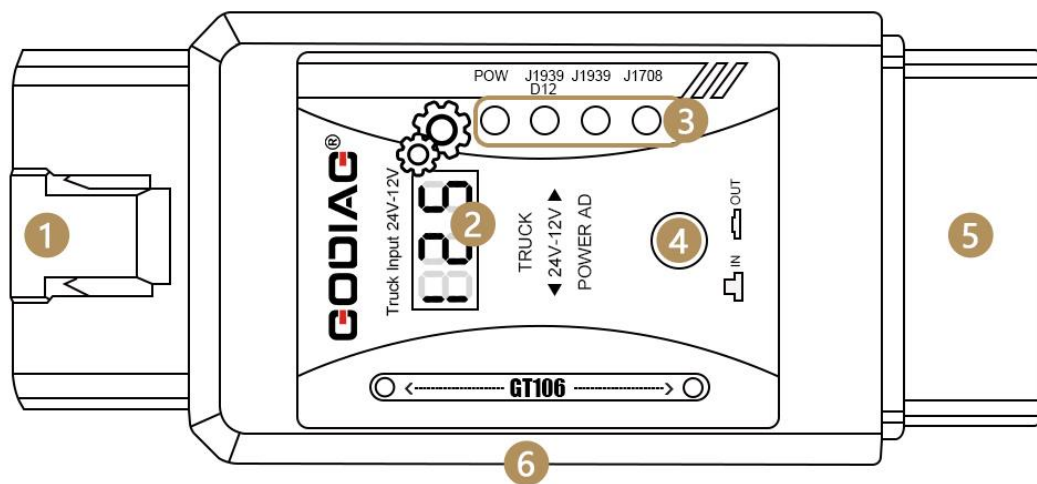

- (1) OBD2 male—used to connect to the 24V truck OBD2 diagnostic interface.
- (2) Display input and output voltage.
- (3) Pow-- power indicator J1939 (PIN12), CANH/J1939 (PIN6), J1708 K-line (PIN7) signal communication indicator. Used to determine whether a device or vehicle is communicating.
- (4) Display input and output voltage function switch button.

(5) OBD2 female—used to connect diagnostic equipment.

(6) DC power input interface.

Functions:

1. Convert the truck diagnostic interface 24V into 12.5V:

Convert the 24V power of the truck diagnostic interface into DC12.5V and supply it to the 12V diagnostic equipment with truck diagnostic software, so as to protect the 12V diagnostic equipment. 12.5V is to simulate the voltage after the vehicle is started, which can ensure that the 12V diagnostic equipment software can normally recognize the voltage after the vehicle is started. **【Some diagnostic software will alarm or stop the diagnosis if it recognizes that the starting voltage of the vehicle is lower than normal.】**

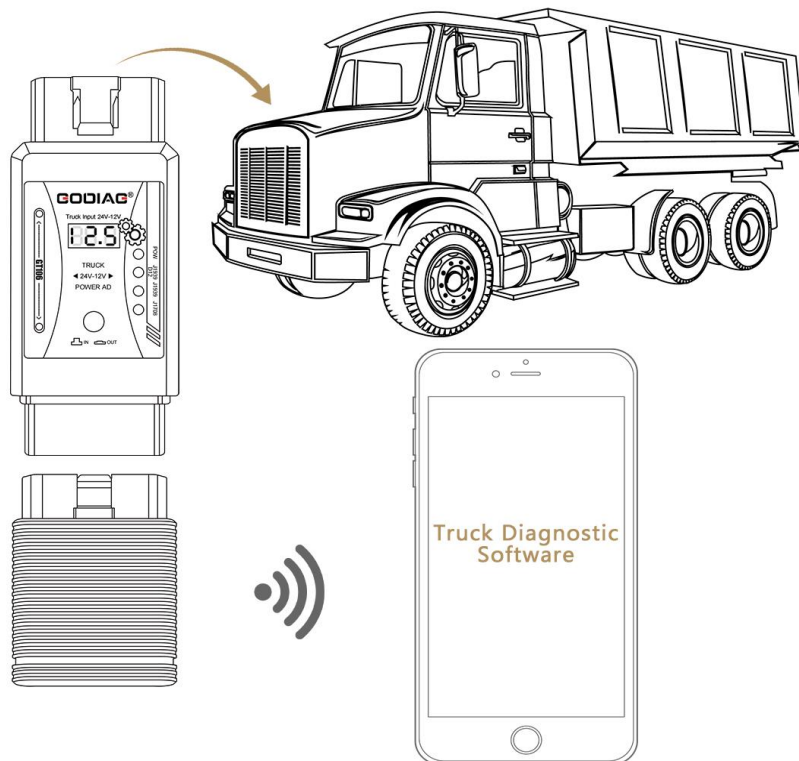

2. Convert 24V truck K-Line signal to 12V K-Line signal:

The 12V diagnostic equipment 7PIN K-Line communication will be burned by the 24V K-line signal of the truck without step-down conversion. GODIAG GT106 24V TO 12V OBD2 Scanner For Heavy Duty Truck Adapter can convert the truck's 24V K-line voltage signal into 12V K-line signal in order to protect the 12V diagnostic equipment 7PIN K-Line communication from being burned by 24V.

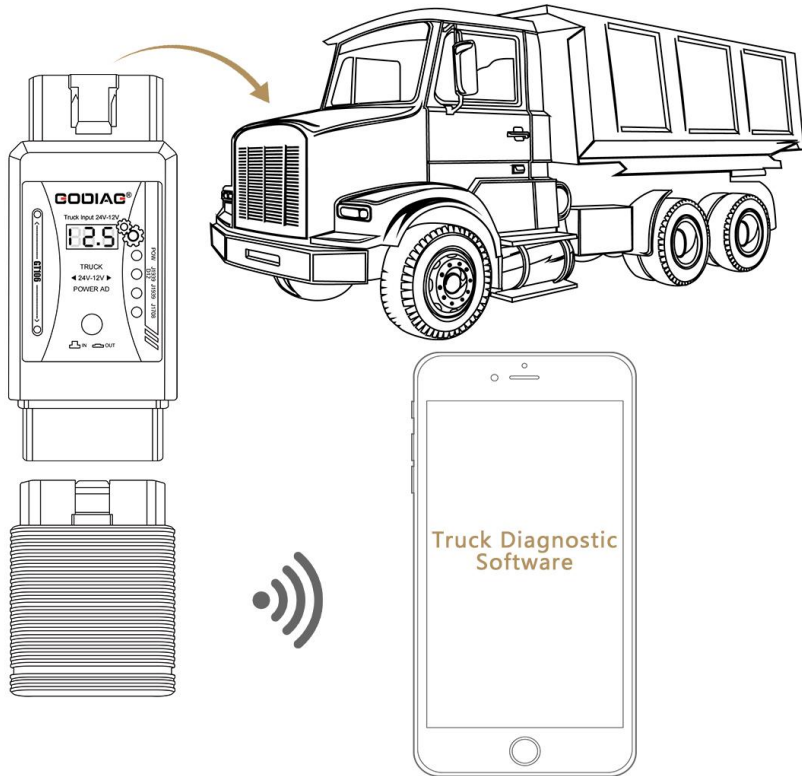

3. Communication indication function:

When J1939 CANH (PIN12), CANH/J1939 (PIN6), J1708 K-line (PIN7) has signal communication such as diagnostic programming, the corresponding indicator light will light up or flash. It can display the current status of communication between the diagnostic equipment and the vehicle.

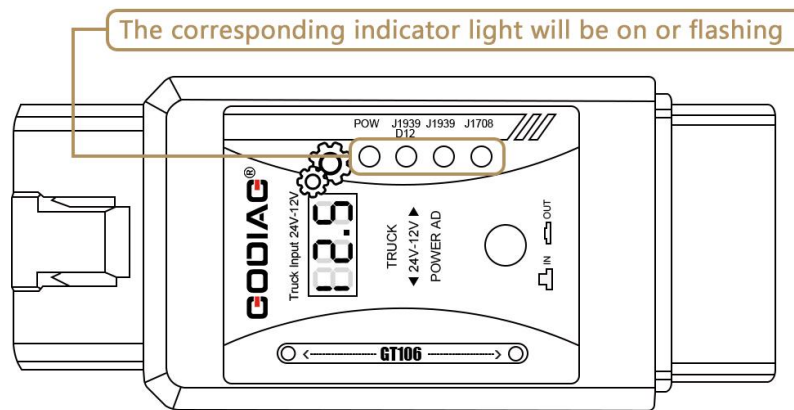

If you do not connect the car and only connect the diagnostic equipment for software communication signal test, you can judge whether the communication of the diagnostic equipment is normal.

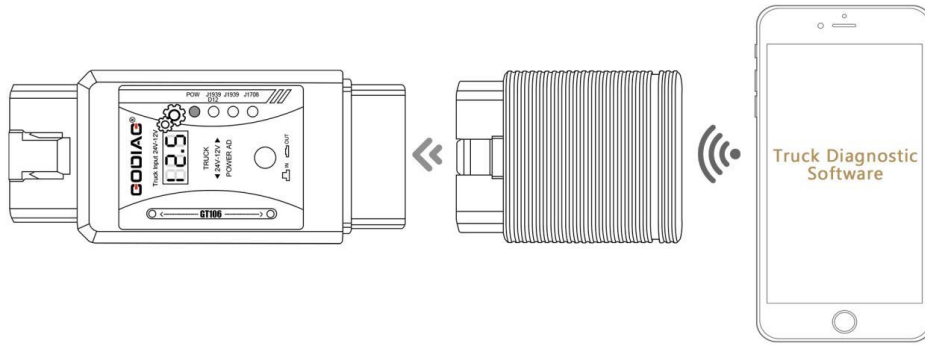

4. Input voltage display function:

The display voltage function displays the currently connected vehicle OBD2 diagnostic interface voltage of 24V when the function switch button is popped up. It can be used to monitor the current vehicle diagnostic interface voltage. If the voltage is found to be abnormal, the operation of the vehicle can be stopped.

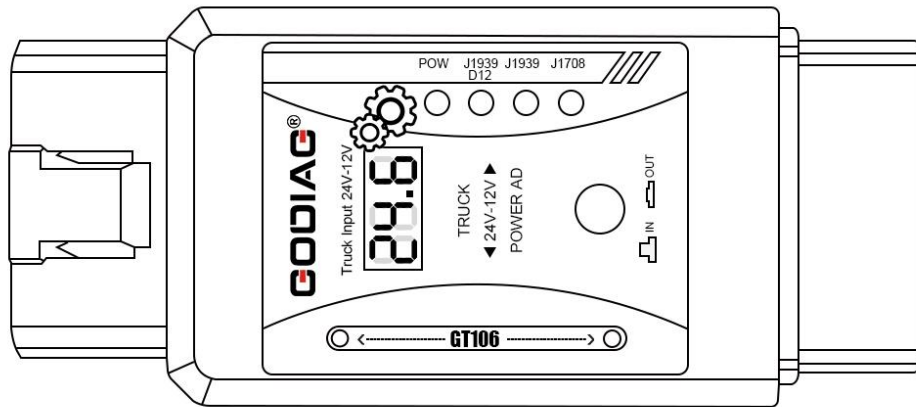

5. Output voltage display function:

When the function switch button is pressed down, the voltage display shows that the voltage of the OBD2 diagnostic output interface after the current conversion is 12.5V. It can be used for equipment self-test before use to ensure that the conversion voltage is normal, which can better protect the 12V diagnostic equipment.

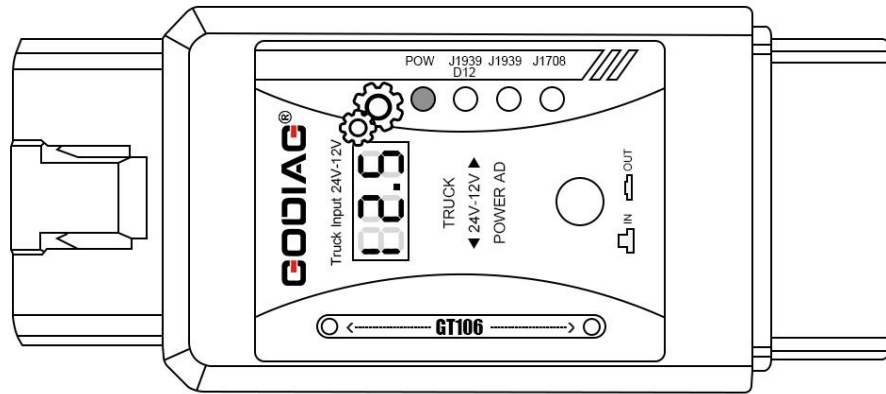

6. DC power interface input function

The DC power input port can be connected to the vehicle power supply, and can also be connected to the power supply in the office. The power supply must be higher than 13V to output normal 12.5V.

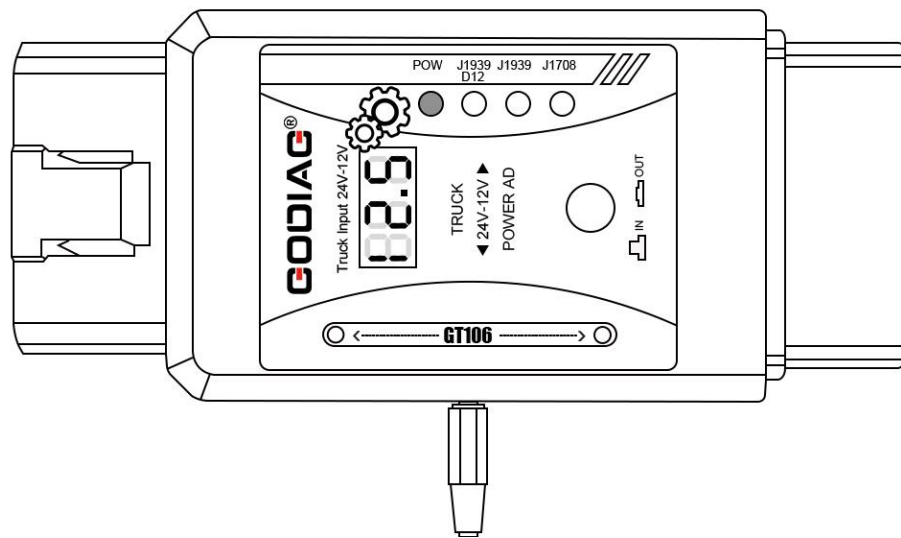

Accessories:

GT106 host 1pc

Manual in paper/PDF electronic document 1pc



Shenzhen Sinoy Technology Co.,Ltd

All Rights Reserved

www.godiag.com

+86 18813687743

Sales@GoDiag.com



Thanks for reading!