

Version: V1.00.000

Revision Date: 10-20-2020

Statement: LAUNCH owns the complete intellectual property rights for the software used by this product. For any reverse engineering or cracking actions against the software, LAUNCH will block the use of this product and reserve the right to pursue their legal liabilities.



## **Copyright Information**

Copyright © 2020 by LAUNCH TECH CO., LTD. All rights reserved. No part of this publication may be reproduced, stored in a retrieval system, or transmitted in any form or by any means, electronic, mechanical, photocopying, recording or otherwise, without the prior written permission of LAUNCH. The information contained herein is designed only for the use of this unit. LAUNCH is not responsible for any use of this information as applied to other units.

Neither LAUNCH nor its affiliates shall be liable to the purchaser of this unit or third parties for damages, losses, costs, or expenses incurred by purchaser or third parties as a result of: Accident, misuse, or abuse of this unit, or unauthorized modifications, repairs, or alterations to this unit, or failure to strictly comply with LAUNCH operating and maintenance instructions. LAUNCH shall not be liable for any damages or problems arising from the use of any options or any consumable products other than those designated as Original LAUNCH Products or LAUNCH Approved Products by LAUNCH.

## **Trademark Information**

LAUNCH is a registered trademark of LAUNCH TECH CO., LTD. (LAUNCH) in China and other countries. All other LAUNCH trademarks, service marks, domain names, logos, and company names referred to in this manual are either trademarks, registered trademarks, service marks, domain names, logos, company names of or are otherwise the property of LAUNCH or its affiliates. In countries where any of the LAUNCH trademarks, service marks, domain names, logos and company names are not registered, LAUNCH claims other rights associated with unregistered trademarks, service marks, domain names, logos, and company names. Other products or company names referred to in this manual may be trademarks of their respective owners. You may not use any trademark, service mark, domain name, logo, or company name of LAUNCH or any third party without permission from the owner of the applicable trademark, service mark, domain name, logo, or company name. You may contact LAUNCH by visiting the website at [www.cnlaunch.com](http://www.cnlaunch.com), or writing to LAUNCH TECH CO., LTD., Launch Industrial Park, North of Wuhe Avenue, Banxuegang, Bantian, Longgang, Shenzhen, Guangdong, P.R.China, to request written permission to use Materials on this manual for purposes or for all other questions relating to this manual.

## Important safety and operation information

To avoid personal injury, property loss, or accidental damage to the product, please read all the information in this section before using the product.

### **Handle device carefully.**

Do not drop, bend, puncture, insert foreign objects, or place heavy objects on the device. The inside fragile components may be damaged.

### **Do not disassemble or refit the device.**

The device is a sealing device and there are no end-user serviceable parts inside. All internal repairs must be carried out by authorized maintenance agencies or authorized technicians. Attempts to disassemble or refit the device will void the warranty.

### **Do not try to replace the internal battery.**

The internal rechargeable battery must be replaced by authorized maintenance agencies or authorized technicians.

## Precautions for vehicle ECU operation

When performing diagnostic operations on a vehicle equipped with the ECU, pay attention to the following items:

- When the ignition switch is turned on, the vehicle internal electrical units must not be disconnected. Otherwise, a high instantaneous voltage will be generated due to the self-inductance of the coil, which will cause damage to the sensor and ECU.
- Do not place magnetic objects such as radio speakers close to the computer, because the speaker magnets can damage the circuits and components in the ECU.
- Do disconnect the ECU system power supply when welding on the vehicle.
- When performing repair work near a computer or sensor, pay more attention to avoiding damage to the ECU and sensor.

- Ground yourself when you disassemble the programmable ROM. Otherwise, ECU circuits can be damaged by static electricity.
- Unless otherwise specified in the test procedure, the ECU and sensor should not be tested with a pointer ohmmeter, but with a high-impedence digital meter.
- Do not use test lamps to test ECU related electrical units in order to prevent ECU or sensor damage, unless otherwise noted.
- When people enter or exit the vehicle, the electrostatic discharge of human body can generate a high voltage of up to 10000V. Therefore, when performing maintenance operations on the digital meter controlled by the ECU or near this meter, be sure to wear a grounded metal strap with one end around the wrist and the other end clamped on the vehicle body.
- Reliably connect the ECU harness connector to avoid damage to the electronic components such as the integrated circuits inside the ECU.

### **FCC Statement**

This device complies with Part 15 of the FCC Rules. Operation is subject to the following two conditions: (1) This device may not cause harmful interference, and (2) this device must accept any interference received, including interference that may cause undesired operation.

**CONTENTS**

<b>1. INTRODUCTION</b> .....	<b>1</b>
1.1 PRODUCT DESCRIPTION .....	1
1.2 COMPONENTS & CONTROLS.....	2
1.3 PERFORMANCE PARAMETERS .....	4
1.4 PACKING LIST .....	6
<b>2. INITIAL USE</b> .....	<b>9</b>
2.1 CHARGING .....	9
2.2 CONNECTION.....	9
2.3 JOB MENU .....	10
<b>3. SENSOR</b> .....	<b>12</b>
3.1 CONNECTION.....	12
3.2 HOW TO OPERATE.....	14
3.2.1 DC Sensor .....	14
3.2.2 AC Sensor.....	19
3.2.3 Frequency Modulation .....	23
<b>4. ACTUATOR</b> .....	<b>27</b>
4.1 CONNECTION.....	27
4.2 HOW TO OPERATE.....	29
4.2.1 Independent Ignition Module (COP) .....	29
4.2.2 Idle Speed Motor .....	30
4.2.3 EGR Valve.....	32
4.2.4 Carbon can solenoid valve.....	33
4.2.5 Turbocharged solenoid valve.....	34
4.2.6 Fuel spray nozzle .....	35
4.2.7 VVT solenoid valve.....	36
4.2.8 Electronic throttle valve assembly, air conditioning fan .....	38
<b>5. DEFINED/DRAWN</b> .....	<b>40</b>
5.1 DEFINED .....	40

5.2 HAND-DRAWN.....	41
<b>6. TIMING WAVEFORM .....</b>	<b>43</b>
<b>7. MULTIMETER.....</b>	<b>45</b>
7.1 HOW TO CONNECT .....	45
7.2 HOW TO OPERATE.....	45
7.3 DETECTION EXAMPLE.....	46





# 1. Introduction

## 1.1 Product Description

This module is specially developed for diagnosing/simulating sensor faults. It mainly includes "Sensor", "Actuator", "Defined/Drawn", and "Timing Waveform". Users can easily and quickly diagnose and simulate the sensor. The sensor is the signal input device of the vehicle ECU. It converts vehicle operating parameters such as vehicle speed, coolant temperature, engine speed, air flow, and throttle opening into electrical signals and sends them to the vehicle ECU. Then, the vehicle ECU adjusts the engine running status to maintain the engine in optimal condition.

At the same time, the module also supports the vehicle multimeter function. Through this function, users can test voltage, resistance, and capacitance. The function uses the same hardware device as the sensor module.

The module cannot be used separately, and must be used together with Launch-specific diagnostic tools compatible with this module.

## 1.2 Components & Controls

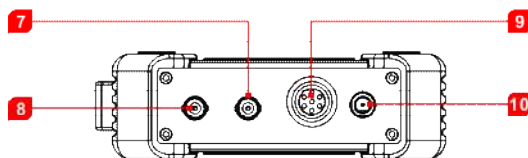
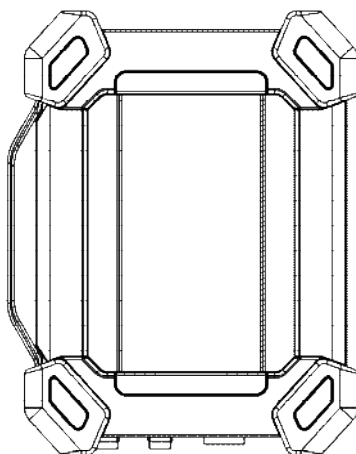
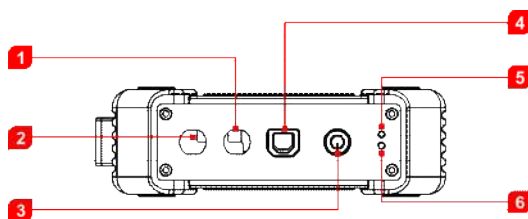

No.	Name	Description
1	COM	Multimeter common

---

2	V/ $\Omega$ /C	Multimeter measuring terminal
3	Power button	Press this button to start up and shut down.
4	USB Type-B interface	<ul style="list-style-type: none"><li>• Connect it to a diagnostic tool for sending data via the USB cable.</li><li>• Connect it to an AC outlet for charging via the USB cable &amp; power adaptor.</li></ul>
5	Battery status LED (green)	If the green lamp is steady on, the battery volume is normal. If the green lamp is flashing at an intermediate speed, the battery volume is low (regardless of whether the red lamp flashes). If the green lamp is flashing at a low speed, charging is in progress.
6	Connection status LED (red)	<ul style="list-style-type: none"><li>• If the red lamp is steady on, the diagnostic tool is connected. If the red lamp is flashing, the diagnostic tool is disconnected.</li><li>• It will enter the charging status only when the red lamp is flashing. The green lamp is flashing at a low speed during charging (if the battery volume is full, it will stay on).</li></ul>
7	CH2	Channel 2
8	CH1	Channel 1
9	7-pin interface	Used to connect 7-pin interface (to six 4mm safety banana head lines) to measure the actuator. When measuring the actuator, it is necessary

---

		to connect the module to the car battery to supply power.
10	Power interface	<p>Power the module through the battery clamps cable.</p> <p><b>⚠ Caution: Users cannot charge this module via this interface directly. It is used to connect the battery clamps cable when performing the Actuator function.</b></p>

### 1.3 Performance Parameters

#### Sensor module:

Parameter	Range
Number of channels	2
Precision	1%
Amplitude range	0~20V
Max output current	20mA
Predefined frequency range	0~20KHz
Square wave signal pulse frequency	0~15KHz
Square wave signal duty cycle	0~100%
Power supply	Simulator sensor output/max current 20mA (output is powered by battery)
	Drive solenoid, ignition coil/output current 2A (external power supply)

<b>USB</b>	USB2.0 (with charging and power supply function/5V)
<b>DC voltage simulation</b>	Support
<b>Fixed frequency simulation</b>	Support
<b>Predefined waveform simulation</b>	Support
<b>Hand-drawn waveform simulation</b>	Support
<b>Signal generator interface</b>	2
<b>External power supply port</b>	1
<b>Solenoid interface</b>	1
<b>Multimeter interface</b>	2
<b>Working temperature</b>	0°C~50°C
<b>Storage temperature</b>	-30°C~70°C

**Multimeter:**

<b>Parameter</b>	<b>Range</b>
<b>DC voltage</b>	0V~700V
<b>AC voltage</b>	0V~700V
<b>Resistance</b>	0Ω~40MΩ
<b>Capacitance</b>	0F~100uF(maximum 30s measurement time)
<b>Diode</b>	0V~1.5V

---

**Continuity detection**

Sounds below 30Ω



---



## 1.4 Packing List



Sensor module accessories include sensor test cables, probes, etc.

Due to different product configurations, the accessories included in the product may be different from those listed in this manual. For the specific accessories included in the product, refer to the packing list attached to the product.

The following is the appearance diagram of each test line and related accessories.

No.	Name	Description	Qt.
1	Sensor module		1
2	HT30 test leads	 <p>A kind of special line used to connect sensors and test various types of signals. Wide-range probes, clamps, and hooks can be inserted into the 4mm connector at the end of the line.</p>	2
3	7-pin interface adapter cable		1

		Used to connect the sensor module and actuator to test the actuator. When testing the actuator, do connect the sensor module to the car battery for power.	
4	Battery clamps cable	 <p>Used to connect the sensor module to the car battery <b>only using the Actuator module</b>.</p>	1
5	USB cable	 <p>Used to connect the sensor module and diagnostic tool, and send the signal collected by the sensor module to the diagnostic tool for waveform display.</p>	1
6	6-way breakout lead	 <p>The 6-way lead is available in 3 joint sizes: 1.0mm, 1.6mm, 2.8mm</p> <p>The lead can be easily connected to the existing car harness interface, which is convenient for reading sensor signals. The output signal is connected to the CH1/CH2 input port of the sensor module through the HT30 test leads from the 4mm banana connector at the other end of the lead.</p>	3

7	Multimeter test pen (black + red)	 <p>During a multimeter function test, it must be connected to the COM and V/<math>\Omega</math>/C terminals of the sensor module.</p>	2
8	Back Probe Pins Suite	 <p>They are mainly used for piercing the insulation of wires to allow for automotive electrical measurements without causing damage to the wires. Additionally they can be used as pin-tip probes while working with small circuit boards.</p>	1
9	Power adaptor	 <p>To charge the sensor module together with the included USB cable.</p>	1



## 2. Initial Use

### 2.1 Charging

- 1) Insert one end (B-type terminal) of the USB cable into the Type-B USB port of the sensor module host, and then insert the other end into the USB port of the power adaptor.

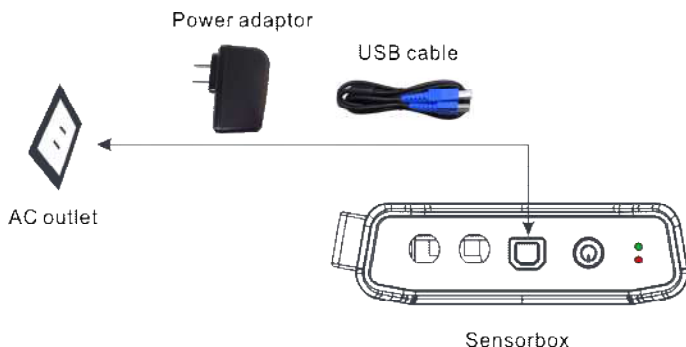

- 2) Plug the power adaptor into the AC outlet to start charging. The green lamp flashes at a low speed. After the charging is complete, the green lamp will keep steady on.

**⚠ Caution:** Please use the included power adaptor to charge your tool. No responsibility can be assumed for any damage or loss caused as a result of using power adaptors other than the one supplied.

**📖 Note:** If the battery remains unused for a long period of time or the battery is completely discharged, it is normal that the Sensorbox will not power on while being charged. Please charge it for a period of 10 minutes and then turn it on.

### 2.2 Connection

- 1) Insert one end (B-type terminal) of the USB cable into the B-type USB port of the sensor module host, and then insert the other end into the USB port of the diagnostic tool.

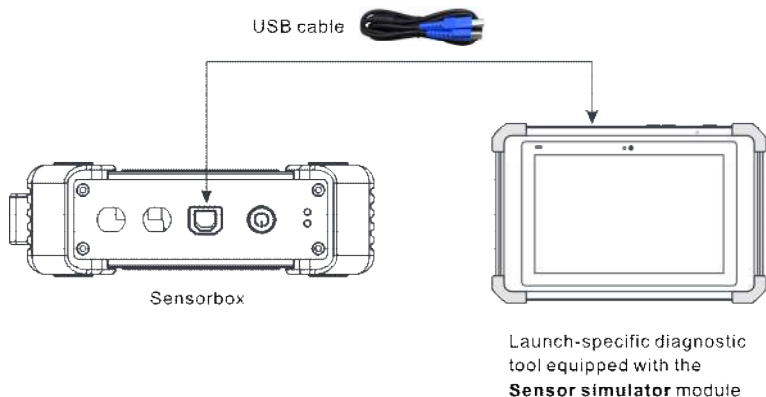

- 2) Press and hold the power button for over 3s to start the sensor module. If the battery volume is normal, the green lamp is steady on.

Indicator lamp status description:

Green lamp	<ul style="list-style-type: none"> <li>• Steady on: normal battery volume.</li> <li>• Flashing at an intermediate speed: low battery volume (regardless of whether red lamp flashes).</li> <li>• Flashing at a low speed: charging in progress.</li> </ul>
Red lamp	<ul style="list-style-type: none"> <li>• Steady on: diagnostic tool connected</li> <li>• Flashing: diagnostic tool disconnected.</li> </ul> <p>It will enter the charging status only when the red lamp is flashing. The green lamp is flashing at a low speed during charging.</p>

- 3) Start the diagnostic tool and access the toolbox. Tap **Sensor Simulator** to access the job menu of sensor.

## 2.3 Job Menu

The sensor module is mainly divided into five function modules.

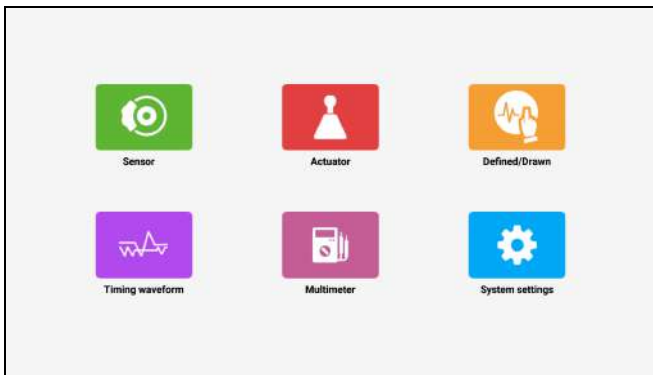

- 1) **Sensor:** Use output voltage or waveform to simulate the working status of the on-board sensor, so as to accurately judge the quality of the sensor and reduce blind replacement of accessories.
- 2) **Actuator:** Used to output PWM signal to drive the on-board coil actuator.
- 3) **Defined/Drawn:** Users can customize sensor waveforms to facilitate future sensor signal simulation.
- 4) **Timing waveform:** Customize timing waveform to match the engine (crankshaft + camshaft), and output in the same phase.
- 5) **Multimeter:** Universal multimeter functions.

## 3. Sensor

### 3.1 Connection

The sensor simulation function can accurately judge the quality of the sensor and reduce blind replacement of accessories. For example, the DTC shows that the water temperature sensor is faulty, but whether it is the fault of the water temperature sensor itself, or the wiring between the sensor and ECU, or the fault of the ECU itself still needs further diagnosis. At this time, the signal of the water temperature sensor can be simulated by the simulation function instead of the water temperature sensor and inputted to the microcomputer. If the engine working condition is improved and the fault symptom disappears, it can be judged as a fault of the water temperature sensor. If the fault symptom persists, directly input the signal at the corresponding terminal of the ECU. If the fault symptom disappears, it is the wiring fault between the water temperature sensor and ECU. If the fault symptom persists, it can be judged as a fault of the ECU itself.

The following connections are required for detecting sensors:

- 1) Connect the sensor module to the diagnostic tool via the USB cable (refer to Chapter 2.2).
- 2) Remove the sensor connected to the ECU.
- 3) According to the specific application and bus terminal types, make the following connections (note: when performing the sensor functions, the hardware output ports of the sensor module are CH1 and CH2).

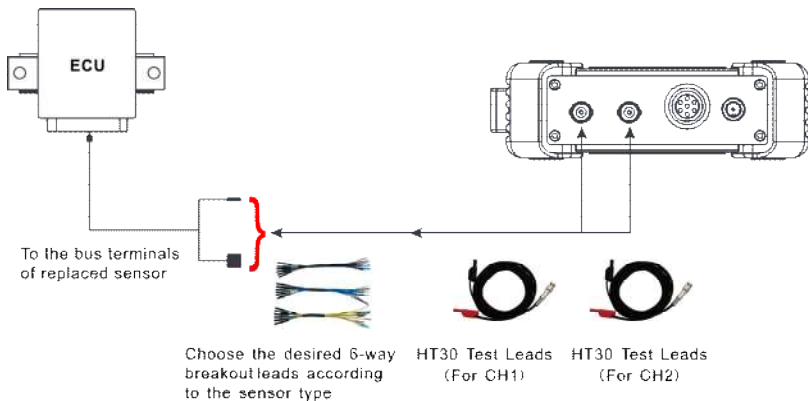

- (1) The BNC connector of the HT30 test line is connected to CH1 or CH2 (can be connected to both CH1 and CH2 as required), and the other end (divided into two ways, red is signal line, black is ground line) is connected to any two ways of the 6-way lead.

 **Note:** When connecting the BNC connector, pay attention to the insertion direction and rotate the connector after insertion to prevent accidental drop.

- (2) Insert the other ends (same color) of the connected two leads into the bus terminal of the replaced sensor (select according to the male and female type of the bus terminal).
- 4) Start the diagnostic tool and access the corresponding sensor module. Tap **Sensor** in the job menu.



## 3.2 How to Operate

There are three types of sensors: DC, AC and frequency modulation PFM.

### 3.2.1 DC Sensor

 Note: The following waveform is a sample waveform, not the actual output waveform. Users can refer to it to change the voltage to achieve the function.

#### 1) Water temperature sensor



**Output port:** CH1

**Output type:** DC voltage

Drag the yellow slider to change the output voltage value of CH1 PEAK to simulate the water temperature change.

 Note: 3v~5v in cold; after warm-up, it goes down to 1v; Negative temperature coefficient sensor.

A simple confirmation method is that the water temperature sensor will link the temperature-controlled fan, and when the voltage is adjusted to a certain threshold, the rotation of the temperature-controlled fan will be started or stopped.

## 2) Intake temperature and pressure sensor

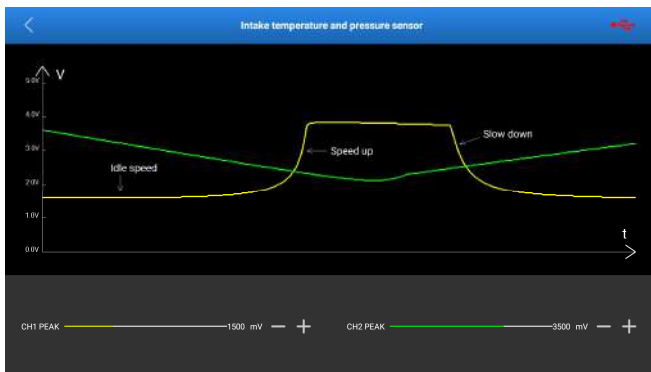

**Output channel:** CH1, CH2

**Output type:** DC voltage

**CH1 PEAK:** intake air temperature. Drag the yellow slider to change the output voltage value of CH1 to simulate the intake air temperature change.

**CH2 PEAK:** intake air pressure. Drag the green slider to change the output voltage value of CH2 to simulate the intake air pressure change.

## 3) Intake pressure sensor

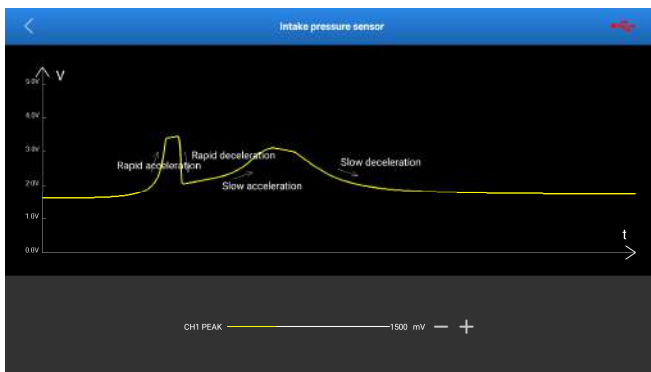

**Output channel:** CH1

**Output type:** DC voltage

Drag the yellow slider to change the output voltage value of CH1 to simulate the intake air pressure change.

#### 4) Throttle position sensor

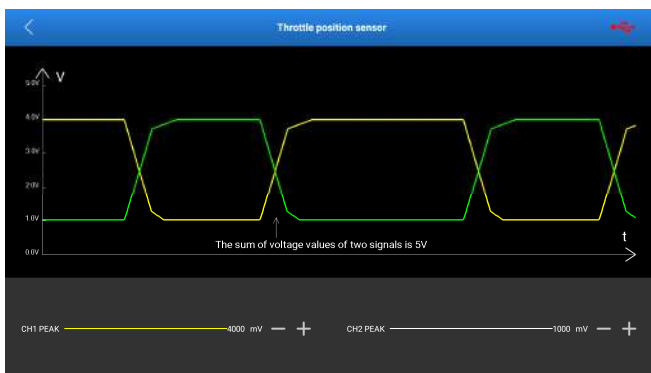

**Output channel:** CH1, CH2

**Output type:** DC voltage

Drag the yellow slider to change the output voltage value of CH1.  
Drag the green slider to change the output voltage value of CH2.



 Note: CH1 and CH2 output voltage at the same time, and the sum of output voltage is 5V. If the voltage of CH1 or CH2 is adjusted separately, the other channel will be linked.

## 5) Accelerator pedal position sensor

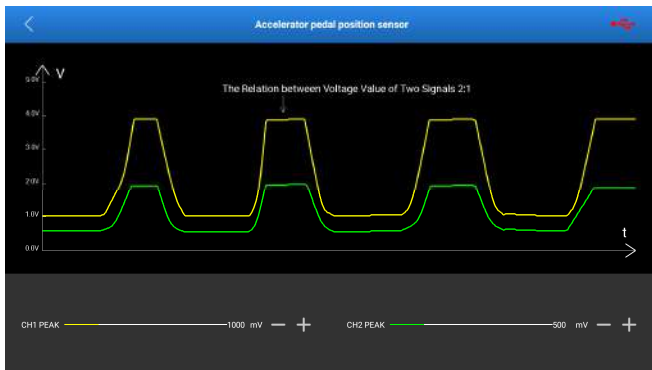

**Output channel:** CH1, CH2 (changes on either of the two channels will cause the other channel to output the corresponding signal)

**Output type:** DC voltage

Drag the yellow slider to change the output voltage value of CH1.

Drag the green slider to change the output voltage value of CH2.

 Note: CH1 and CH2 output voltage at the same time, and the ratio of CH1 output voltage to CH2 output voltage is 2:1. If the voltage of CH1 or CH2 is adjusted separately, the other channel will be linked.

## 6) Air flow sensor

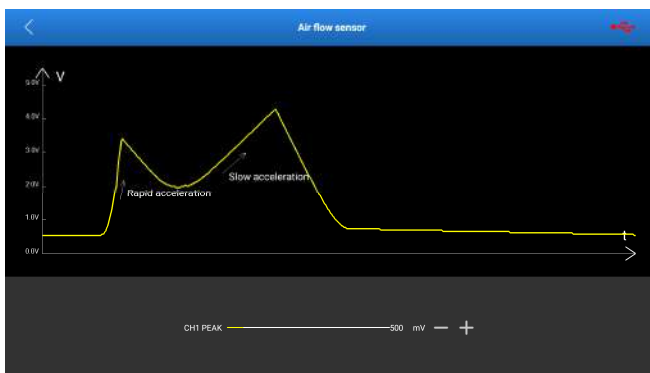

**Output channel:** CH1

**Output type:** DC voltage

Drag the yellow slider to change the output voltage value of CH1 to simulate the air flow.

## 7) Zirconia type oxygen sensor

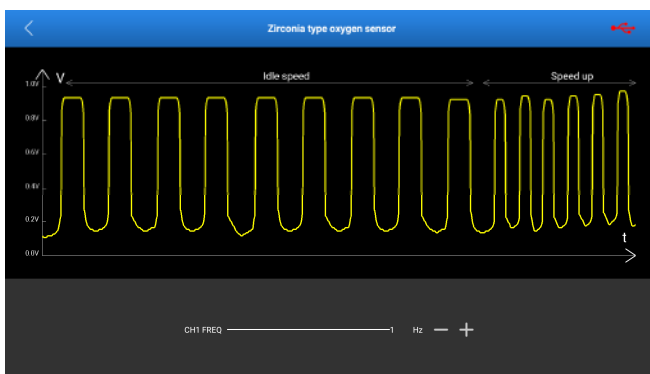

**Output channel:** CH1

**Output type:** square wave

Drag the yellow slider to change the output frequency of CH1 to simulate the

acceleration and deceleration status.

## 8) Titanium dioxide type oxygen sensor

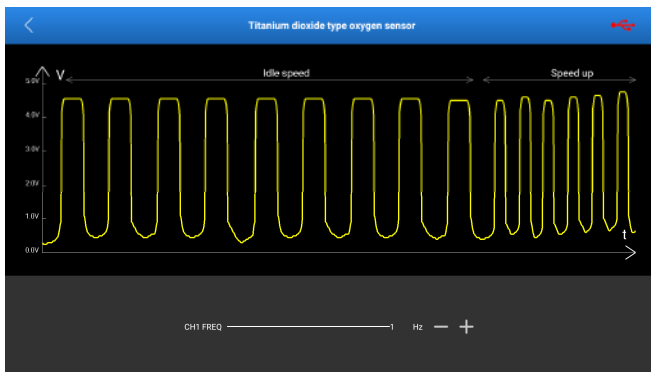

**Output channel:** CH1

**Output type:** square wave

Drag the yellow slider to change the output frequency of CH1 to simulate the acceleration and deceleration status.

### 3.2.2 AC Sensor

 Note: The following waveform is a sample waveform, not the actual output waveform. Users can refer to it to change the parameter to achieve the function.

#### 1) Magneto-electric crankshaft position sensor

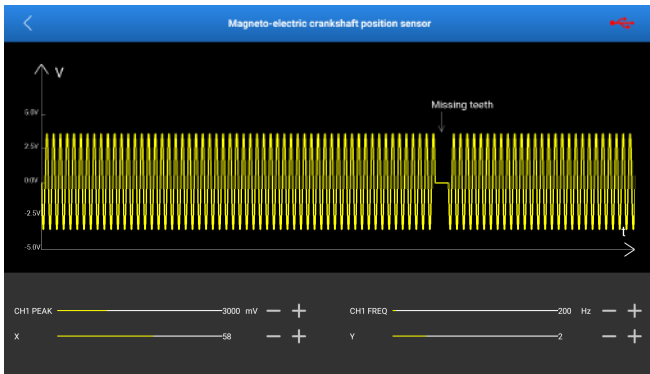

**Output channel:** CH1

**Output type:** sine wave

Drag the CH1 amplitude slider to change the output amplitude.

Drag the CH1 frequency slider to change the output frequency.

X is used to change the output quantity of sine wave x. Y is used to change the output quantity of the straight line y.

 Note: X indicates how many sine waves are output at a time. Y indicates how many linear voltages are output after the output of X (the period of X sine wave is 1). The values of X and Y are determined by the actual hardware parameters.

Take X=8 and Y=2 as an example, as shown in the following figure.

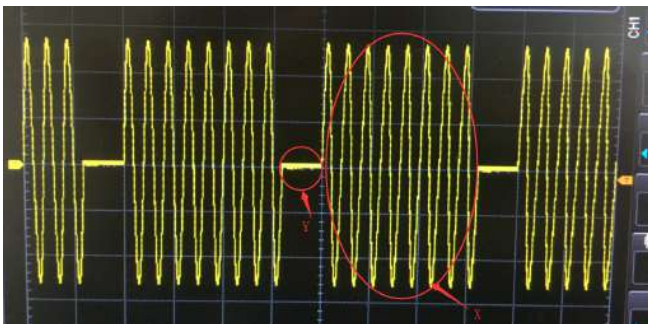

## 2) Magneto-electric camshaft position sensor

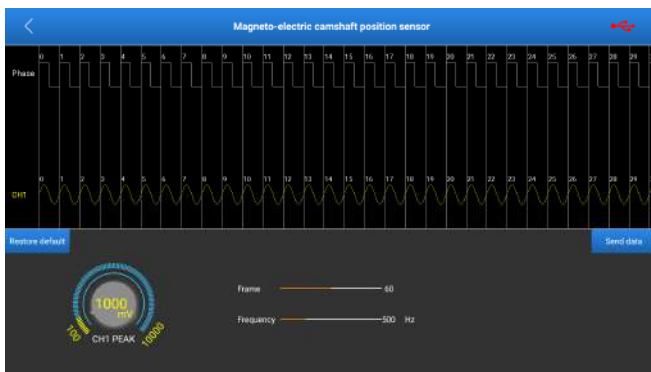

**Output channel:** CH1

**Output type:** sine wave

Drag the frame slider to change the total number of frames that is output at a time.

Drag the frequency slider to change the output frequency.

Turn the knob of CH1 PEAK to change the amplitude value.

 **Note:** Phase is the clock. The frame number indicates how many clock-corresponding waveforms are output at a time (for example, for 50 frames, 50 waveforms will be output cyclically). The waveform corresponding to the upper CH1 is compatible (there are positive sine wave, reverse sine wave, linear voltage). Users can edit them as required (the specific parameters are determined by hardware parameters). For details, see **Timing waveform**.

### 3) Magneto-electric ABS wheel speed sensor

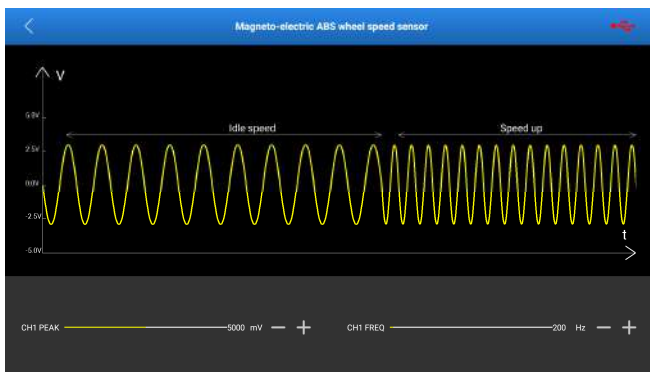

**Output channel:** CH1

**Output type:** sine wave

Drag the CH1 amplitude slider to change the output waveform amplitude.

Drag the CH1 frequency slider to change the output waveform frequency to simulate idle speed and acceleration status.

### 4) Magneto-electric speed sensor

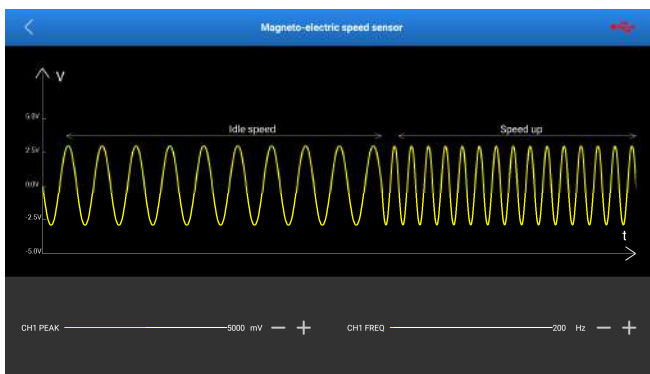

**Output channel:** CH1

**Output type:** sine wave

Drag the CH1 amplitude slider to change the output waveform amplitude.

Drag the CH1 frequency slider to change the output waveform frequency to simulate idle speed and acceleration status.

### 5) Knock sensor

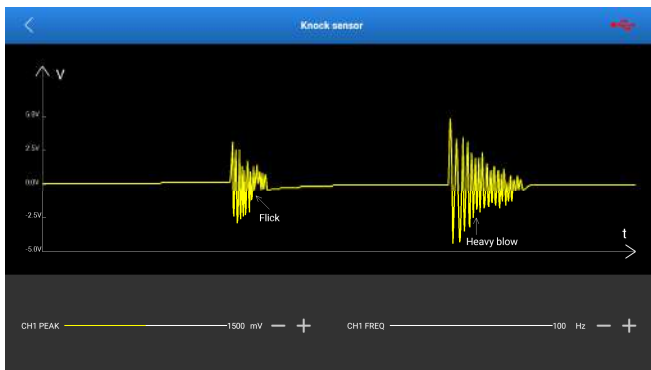

**Output channel:** CH1

**Output type:** shockwave

Drag the CH1 PEAK slider to change the output waveform amplitude to simulate the magnitude of vibration.

Drag the CH1 FREQ slider to change the output waveform frequency to simulate the speed of vibration.

### 3.2.3 Frequency Modulation

 Note: The following waveform is a sample waveform, not the actual output waveform. Users can refer to it to change the frequency to achieve the function.

## 1) Digital air flow sensor

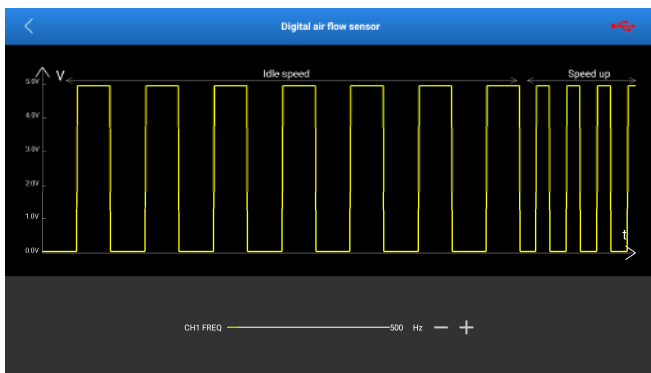

**Output channel:** CH1

**Output type:** square wave

Drag the yellow slider to change the output frequency of CH1 to simulate the acceleration and deceleration status.

## 2) Reluctance ABS wheel speed sensor

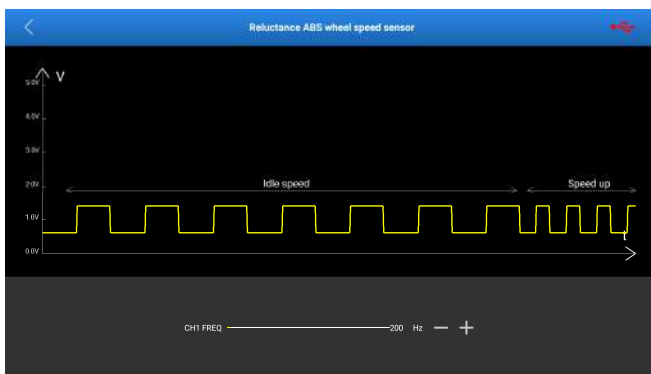

**Output channel:** CH1

**Output type:** square wave

Drag the yellow slider to change the output frequency of CH1 to simulate the



acceleration and deceleration status.

### 3) Hall speed sensor

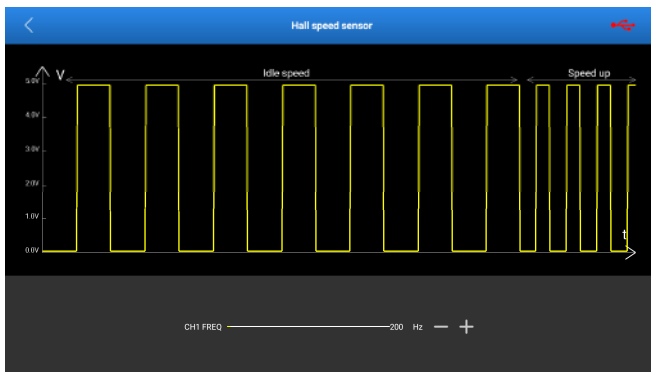

**Output channel:** CH1

**Output type:** square wave

Drag the yellow slider to change the output frequency of CH1 to simulate the acceleration and deceleration status.

### 4) Hall crankshaft sensor

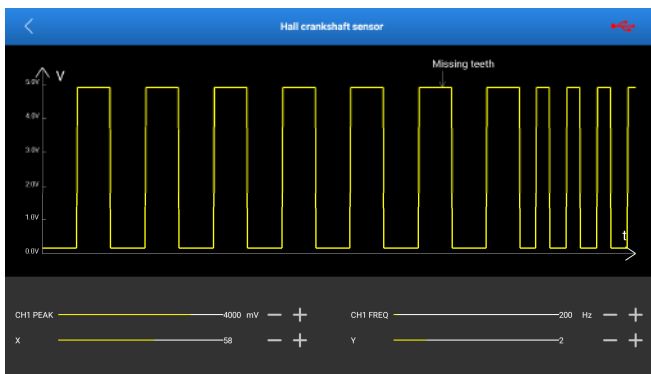

**Output channel:** CH1

**Output type:** square wave

Drag the CH1 PEAK slider to change the output amplitude.

Drag the CH1 FREQ slider to change the output frequency.

X is used to change the output quantity of square wave x. Y is used to change the output quantity of the straight line y.

 Note: X indicates how many square waves are output at a time. Y indicates how many linear voltages are output after the output of X (the period of X square wave is 1). The values of X and Y are determined by the actual hardware parameters.

### 5) Hall camshaft sensor

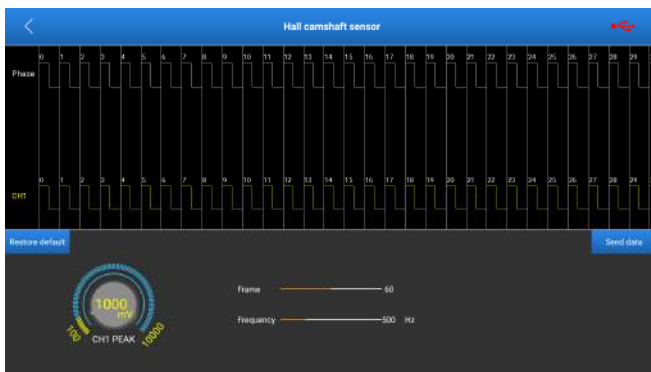

**Output channel:** CH1

**Output type:** square wave

Drag the frame slider to change the total number of frames that is output at a time.

Drag the frequency slider to change the output frequency.

Turn the knob of CH1 PEAK to change the amplitude value.

 Note: Phase is the clock. The frame number indicates how many clock-corresponding waveforms are output at a time (for example, for 50 frames, 50 waveforms will be output cyclically). The waveform corresponding to the upper CH1 is compatible (there are positive square wave, reverse square wave, linear voltage). Users can edit them as required (the specific parameters are determined by hardware parameters). For details, see **Timing waveform**.

## 4. Actuator

### 4.1 Connection

This function is used to output PWM signals to drive the vehicle-mounted coil actuator to work, and check the working status to confirm the quality of the actuator.

The following connections are required for detecting the function:

- 1) Connect the sensor module to the diagnostic tool via the USB cable (refer to Chapter 2.2).
- 2) According to the specific application and actuator type, connect as follows  
 Note: when performing the actuator function, ensure that the hardware output channel of the sensor module is 7-pin interface.)

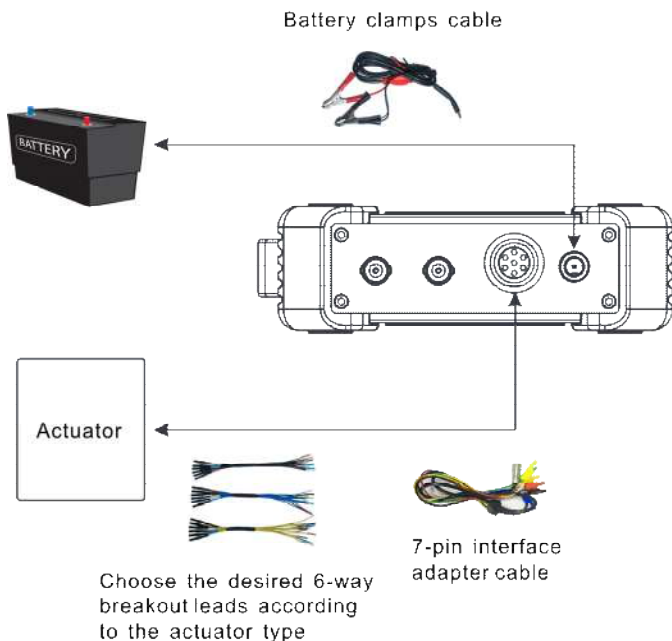

- 1) Connect one end of the 7-pin interface adapter cable to the 7-pin interface, and connect the other end (there are 6 safety banana head lines, each safety banana head line is numbered and with positive and negative terminals, which must be noted during use) to the 6-way breakout leads as required.

 **Note:** When connecting the 7-pin interface adapter cable to the 7-pin interface on the sensor module, pay attention to the alignment of the two red dots and then insert the adapter cable. After successful insertion, you will hear a beep. When you pull out the adapter cable, do not pull it directly by force. First, press and hold the cover marked with red dots with your fingers, slowly dial outward, and then gently pull out the cable.

- 2) Insert the other ends (same colors) of the leads into the corresponding jacks of the actuator (for the specific connection method, see Chapter 4.1).
- 3) Start the diagnostic tool and access the corresponding sensor module. Tap **Actuator** in the job menu.

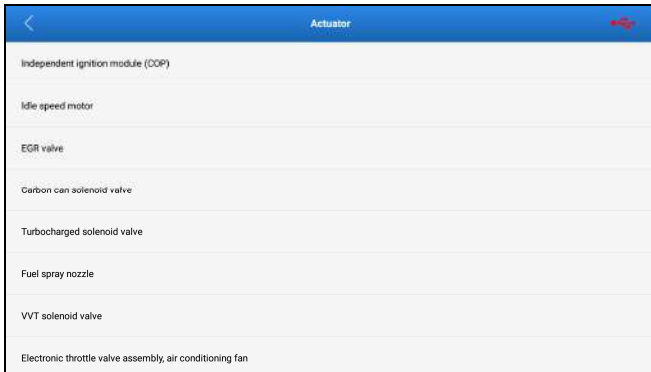

## 4.2 How to Operate

The actuators are classified as follows: independent ignition module (COP), idle speed motor, EGR valve, carbon can solenoid valve, turbocharged solenoid valve, fuel spray nozzle, VVT solenoid valve, electronic throttle valve assembly, air conditioning fan.

 Note: The types of actuators are not limited to those given above, but their working principles are the same. You can drive an actuator on any page under the condition of knowing the working parameters of the actuator. For example, actuator A is not listed above, but its working parameters are similar to the fan, you can drive actuator A on the page of "Electronic throttle valve assembly, air conditioning fan".

The following waveform is a sample waveform, not the actual output waveform.

### 4.2.1 Independent Ignition Module (COP)

#### Wiring mode:

Line 1: Solenoid -

Line 2: CH1\2 grounded

Line 3: Solenoid +

Line 4: CH1\2 output



#### Operation method:

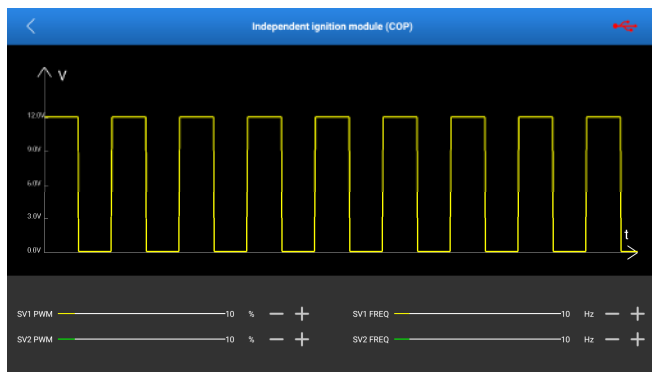

**Output ports:** solenoid 1 (SV1) and solenoid 2 (SV2)

**Output type:** adjustable duty cycle square wave

Drag the SV1 PWM slider to change the output duty cycle of SV1. Drag the SV1 FREQ slider to change the output frequency of SV1.

Drag the SV2 PWM slider to change the output duty cycle of SV2. Drag the SV2 FREQ slider to change the output frequency of SV2.

 **Note:** In the menu, adjust the duty cycle of SV1/SV2 to 100%. Select the waveform of the corresponding channel as square wave in the customization, set the frequency to 10HZ, duty cycle to 10%, and amplitude to 5V. (The independent ignition module is a modular actuator, which requires the solenoid port and the sensor port to be used at the same time. Other modular actuators can refer to it.)

## 4.2.2 Idle Speed Motor

**Wiring mode:**

Line 1: SV1 +

Line 2: SV2 +

Line 3: SV2 -

Line 4: SV1 -

 **Note:** This is a coil actuator.



### Operation method:

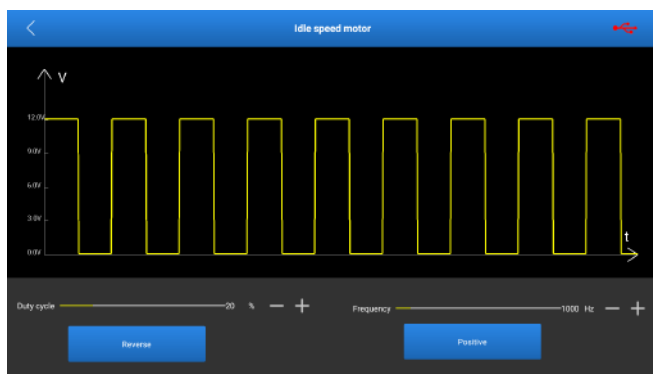

**Output ports:** solenoid 1 (SV1) and solenoid 2 (SV2)

**Output type:** adjustable duty cycle square wave

Drag the duty cycle sliders to change the output duty cycles of SV1 and SV2. Drag the frequency sliders to change the output frequencies of SV1 and SV2.

If you press **Reverse**, the stepper motor will rotate one step in reverse according to the hardware connection. If you press **Positive**, the stepper motor will rotate one step in the forward direction according to the hardware connection.

 Note: Changing the duty cycle and frequency does not directly drive the stepper

motor. The stepper motor can react only by tapping the **Reverse** or **Positive** button. (The so-called forward and reverse directions are not fixed, and are determined by the hardware connection.)

### 4.2.3 EGR Valve

#### Wiring mode:

Line 1: SV1\2 +

Line 2: Not connected

Line 3: Not connected

Line 4: Not connected

Line 5: SV1\2 -

 Note: This is a coil actuator.



**Operation method:**



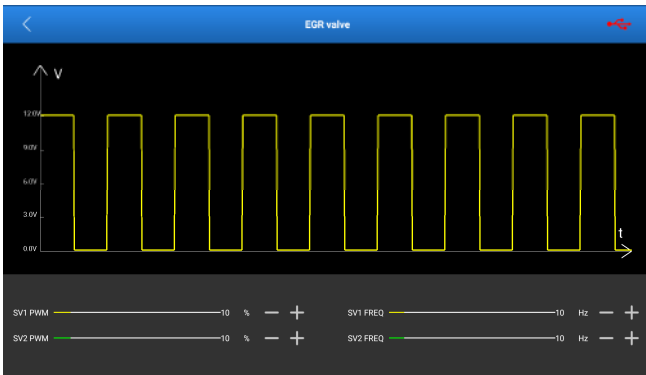

**Output ports:** solenoid 1 (SV1) and solenoid 2 (SV2)

**Output type:** adjustable duty cycle square wave

Drag the PWM sliders to change the output duty cycles of SV1 and SV1. Drag the FREQ sliders to change the output frequencies of SV1 and SV2.

#### 4.2.4 Carbon can solenoid valve

**Wiring mode:**

Line 1: SV1\2 +

Line 2: SV1\2 -

 Note: This is a coil actuator.



**Operation method:**

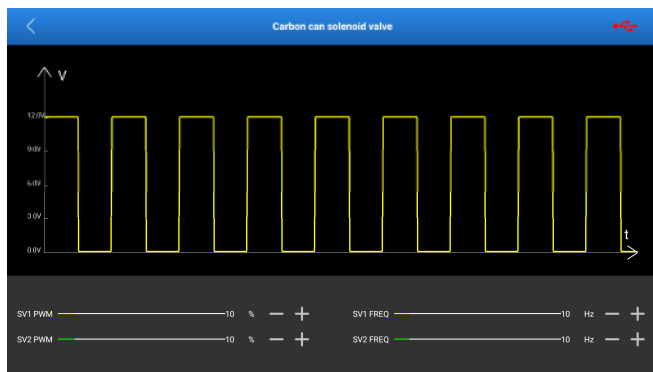

**Output ports:** solenoid 1 (SV1) and solenoid 2 (SV2)

**Output type:** adjustable duty cycle square wave

Drag the SV1 PWM slider to change the output duty cycle of SV1. Drag the SV1 FREQ slider to change the output frequency of SV1.

Drag the SV2 PWM slider to change the output duty cycle of SV2. Drag the SV2 FREQ slider to change the output frequency of SV2.

#### 4.2.5 Turbocharged solenoid valve

**Wiring mode:**

Line 1: SV1\2 +

Line 2: SV1\2 -

 Note: This is a coil actuator.



**Operation method:**

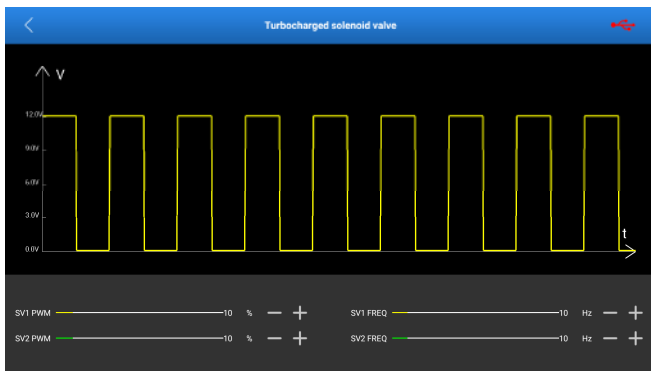

**Output ports:** solenoid 1 (SV1) and solenoid 2 (SV2)

**Output type:** adjustable duty cycle square wave

Drag the SV1 PWM slider to change the output duty cycle of SV1. Drag the SV1 FREQ slider to change the output frequency of SV1.

Drag the SV2 PWM slider to change the output duty cycle of SV2. Drag the SV2 FREQ slider to change the output frequency of SV2.

#### 4.2.6 Fuel spray nozzle

**Wiring mode:**

Line 1: SV1\2 +

Line 2: SV1\2 -

 Note: This is a coil actuator.



### Operation method:

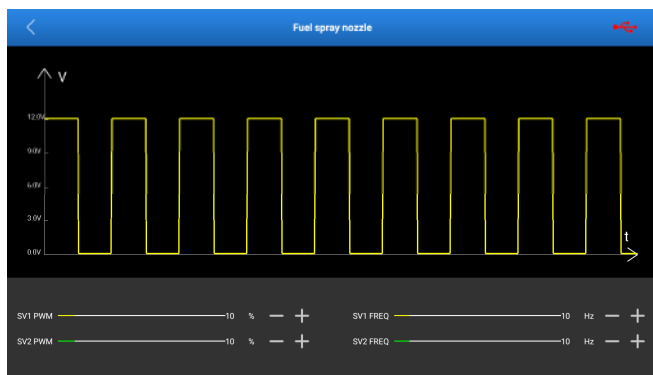

**Output ports:** solenoid 1 (SV1) and solenoid 2 (SV2)

**Output type:** adjustable duty cycle square wave

Drag the SV1 PWM slider to change the output duty cycle of SV1. Drag the SV1 FREQ slider to change the output frequency of SV1.

Drag the SV2 PWM slider to change the output duty cycle of SV2. Drag the SV2 FREQ slider to change the output frequency of SV2.

### 4.2.7 VVT solenoid valve

#### Wiring mode:

Camshaft exhaust valve

Line 1: SV1\2 +

Line 2: SV1\2 -

Camshaft intake valve

Line 3: SV1\2 +

Line 4: SV1\2 -

 Note: This is a coil actuator.



**Operation method:**

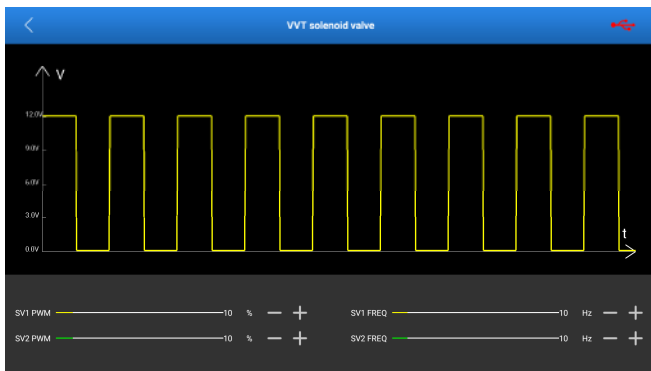

**Output ports:** solenoid 1 (SV1) and solenoid 2 (SV2)

**Output type:** adjustable duty cycle square wave

Drag the SV1 PWM slider to change the output duty cycle of SV1. Drag the SV1 FREQ slider to change the output frequency of SV1.

Drag the SV2 PWM slider to change the output duty cycle of SV2. Drag the SV2 FREQ slider to change the output frequency of SV2.

## 4.2.8 Electronic throttle valve assembly, air conditioning fan

### Wiring mode:

Electronic throttle assembly:

Line 1: SV1\2 +

Line 2: SV1\2 -

 Note: This is a coil actuator.



### A/C fan:

Line 1: SV1\2 +

Line 2: SV1\2 -

 Note: This is a coil actuator.



### Operation method:

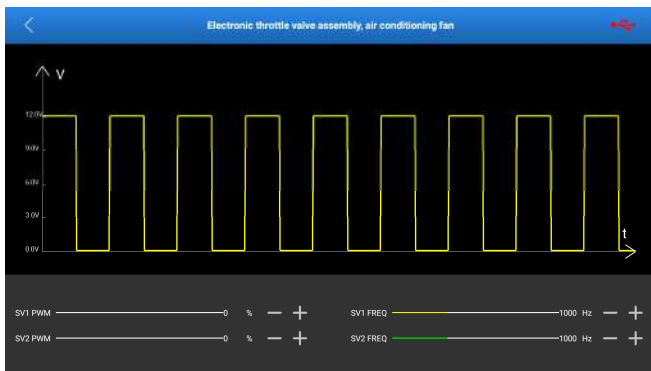

**Output ports:** solenoid 1 (SV1) and solenoid 2 (SV2)

**Output type:** adjustable duty cycle square wave

Drag the SV1 PWM slider to change the output duty cycle of SV1. Drag the SV1 FREQ slider to change the output frequency of SV1.

Drag the SV2 PWM slider to change the output duty cycle of SV2. Drag the SV2 FREQ slider to change the output frequency of SV2.

## 5. Defined/Drawn

Defined means that users operate by themselves with no special restriction and various defined waveforms can be switched and output at any time. In addition to customization, it also supports hand-drawing, which has a great degree of freedom.

### 5.1 Defined

Refer to Chapter 3.1 for connection methods.

Tap **Defined/Drawn** on the sensor module function main page to access the following page.

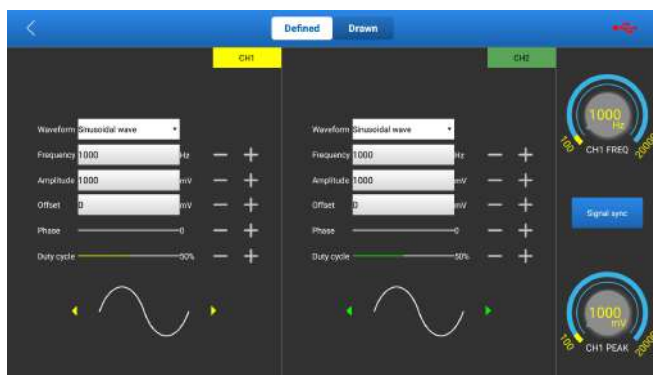

The output channels corresponding to customization are CH1 and CH2.

The parameters can be set as follows:

- **Waveform:** There are 9 waveforms to choose. Forward sine wave, reverse sine wave, forward square wave, reverse square wave, medium voltage straight line, high voltage straight line, low voltage straight line, triangle wave, and trapezoidal wave.
- **Frequency:** set the frequency of the selected waveform.
- **Amplitude:** set the amplitude of the selected waveform.
- **Offset:** set the offset of the selected waveform.



- **Phase:** set the phase of the selected waveform.
- **Duty cycle:** set the duty cycle of the selected waveform.

**Signal sync** can cause CH1 and CH2 to output signals at the same time.

## 5.2 Hand-drawn

The hand-drawing function facilitates users to simulate special waveforms or fault waves. Users only need to draw the shape of the simulated waveform in the upper drawing area, and set the waveform, frequency, and amplitude in the parameter setting area.

Tap **Drawn** to switch to the drawing mode.

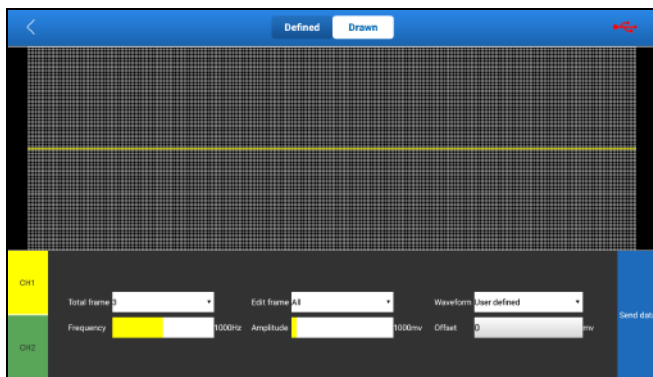

The corresponding output channels are CH1 and CH2.

The upper area on the page is the drawing area. Select CH1 and CH2 manually.

The parameters can be set as follows:

- **Total frame:** 1-3 (optional). Indicate the total number of output points. Generally, one waveform is composed of 100 points. The values 1-3 indicate that you can select 100, 200, or 300 points to form a waveform.
- **Edit frame:** You can edit a single frame or edit all.
- **Waveform:** You can select a preset waveform and place it in the hand-drawing area.
- **Frequency:** Frequency of a single frame (for 3-frame output, the total frequency is the set frequency/3).

- **Amplitude:** Amplitude of the output waveform.
- **Offset:** Offset of the output waveform.

When drawing a waveform, if you lift the finger at the edge, the drawn waveform will be sent out automatically.

## 6. Timing Waveform

The function is used to match the timing waveform (crankshaft + camshaft) of the engine.

Refer to Chapter 3.1 for connection methods.

Tap **Timing Waveform** on the sensor module function main page to access the following page.

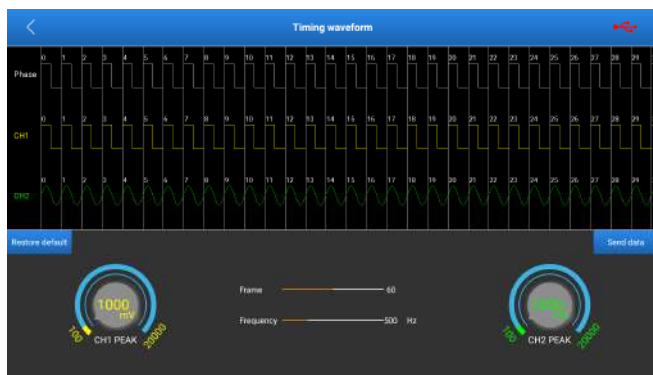

The corresponding output channels are CH1 and CH2.

CH1 simulates camshaft signals.

CH2 simulates crankshaft signals.

CH1 waveforms in each cycle are adjustable, and the options are as follows (take cycle 0 as an example).

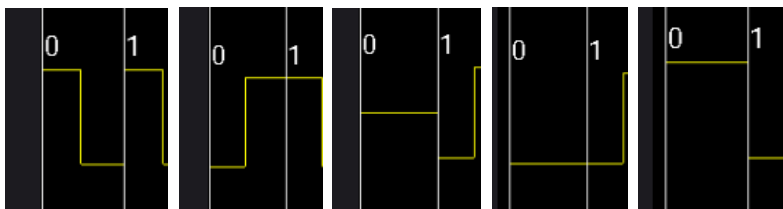

As shown, five waveforms can be selected in cycle 0. They are forward square

wave, reverse square wave, medium straight line level, low straight line level, and high straight line level.

CH2 waveforms in each cycle are adjustable, and the options are as follows (take cycle 0 as an example).

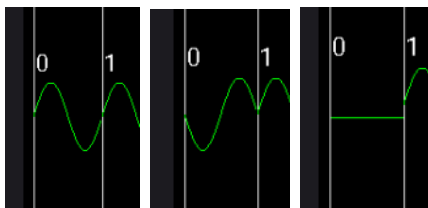

As shown, three waveforms can be selected in cycle 0. They are forward sine wave, reverse sine wave, and medium straight line level.

The specific waveform editing of CH1 and CH2 should be determined according to different engines.

**Frame:** Number of editing waveforms that are output at a time (it is cyclic output for 50 frames, 50 editing waveforms are output at a time.)

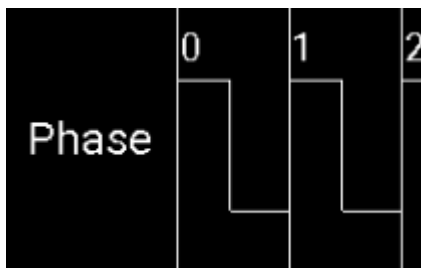

Indicate that the editing waveforms of CH1 and CH2 in the same cycle are in the same phase.

**Frequency:** Frequencies of CH1 and CH2 will be changed at the same time.

**Amplitude:** Amplitudes of CH1 and CH2 are separately set.

## 7. Multimeter

### 7.1 How to Connect

- 1) First, power on the sensor module.
- 2) Connect the B-type terminal of the USB cable to the B-type interface, and the other end to the USB interface of the diagnostic tool.
- 3) Connect one end of the multimeter test line (black) to the COM interface of the sensor module.
- 4) Connect one end of the multimeter test line (red) to the V/ $\Omega$ /C interface of the sensor module.

### 7.2 How to Operate

 Note: All multimeters are A/T multimeters. There is no M/T multimeter.

Tap **Multimeter** on the sensor module function main page to access the following page.

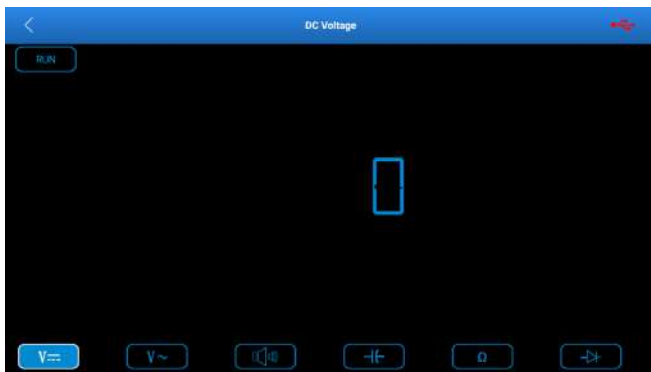

Multimeter functions include:

: DC voltage

: AC voltage

: On-off

: Capacitance



: Resistance

: Diode

## 7.3 Detection Example

### Knock sensor detection

#### (1) Detect knock sensor resistance

Turn off the ignition switch, disconnect the knock sensor wire connector, and use "resistance measurement " to detect the resistance between the knock sensor wire terminal and the housing. The resistance should be  $\infty$  (non-conducting). If the resistance is  $0\Omega$  (conducting), the knock sensor must be replaced. For the magnetostrictive knock sensor, "resistance measurement " can also be used to detect the coil resistance. The resistance should meet the specified value (for the specific data, see the service manual). Otherwise, the knock sensor must be replaced.

#### (2) Check knock sensor output signal

Remove the knock sensor plug. Use "voltage test" to check the voltage between the knock sensor wire terminal and ground when the engine is idling. There should be a pulse voltage output. If not, the knock sensor must be replaced.

### Coolant temperature sensor detection

#### (1) Detect coolant temperature sensor resistance

Check on the vehicle: Turn off the ignition switch, disconnect the coolant temperature sensor wire connector, and use "resistance measurement " to test the resistance between the two terminals of the sensor. Its resistance value is inversely proportional to the temperature (negative temperature coefficient) and should be less than  $1k\Omega$  during warm-up.

Single piece check: disconnect the coolant temperature sensor wire connector, remove the sensor from the engine, place the sensor into the water in the beaker, heat the water in the beaker, and use "resistance measurement " to test the resistance between the two terminals of the sensor under different water

temperature conditions. Compare the measured value with the standard value. If the standard value is not met, the coolant temperature sensor should be replaced.

(2) Detect coolant temperature sensor output signal voltage

Install the coolant temperature sensor, insert the sensor wire connector, turn on the ignition switch, and test the sensor output voltage signal between the two terminals of the coolant temperature sensor wire connector. The measured voltage value should vary inversely with the coolant temperature. When the coolant temperature sensor harness is disconnected and the ignition switch is on, the voltage should be about 5V.





---

## **Warranty**

THIS WARRANTY IS EXPRESSLY LIMITED TO PERSONS WHO PURCHASE LAUNCH PRODUCTS FOR PURPOSES OF RESALE OR USE IN THE ORDINARY COURSE OF THE BUYER'S BUSINESS.

LAUNCH electronic product is warranted against defects in materials and workmanship for one year from date of delivery to the user.

This warranty does not cover any part that has been abused, altered, used for a purpose other than for which it was intended, or used in a manner inconsistent with instructions regarding use. The exclusive remedy for any automotive meter found to be defective is repair or replacement, and LAUNCH shall not be liable for any consequential or incidental damages.

Final determination of defects shall be made by LAUNCH in accordance with procedures established by LAUNCH. No agent, employee, or representative of LAUNCH has any authority to bind LAUNCH to any affirmation, representation, or warranty concerning LAUNCH automotive meters, except as stated herein.

## **Disclaimer**

The above warranty is in lieu of any other warranty, expressed or implied, including any warranty of merchantability or fitness for a particular purpose.

## **Purchase Order**

Replaceable and optional parts can be ordered directly from your LAUNCH authorized tool supplier. Your order should include the following information:

Order quantity

Part number

Part name

## **Customer Service**

Any question during the operation, please call 86-755-84557891.

If your unit requires repair service, return it to the manufacturer with a copy of the sales receipt and a note describing the problem. If the unit is determined to be in warranty, it will be repaired or replaced at no charge. If the unit is determined to be out of warranty, it will be repaired for a nominal service charge plus return freight. Send the unit pre-paid to:

---

Attn: Customer Service Department

LAUNCH TECH CO., LTD.

Launch Industrial Park,

North of Wuhe Avenue,

Banxuegang, Bantian,

Longgang, Shenzhen, Guangdong

P.R.China, 518129

Launch website: <http://www.cnlaunch.com>

<http://www.x431.com>

---

Statement: Launch reserves the rights to change the product design and specifications without prior notice. The appearance and color of the actual product may be different from those shown in the manual. Please refer to the actual product. We have tried our best to make all the descriptions in the manual accurate, but it is still inevitable that there are inadequacies. If you have any questions, please contact the dealer or Launch after-sales service center. We will not bear any consequences arising from misunderstandings.



---

版本号：V1.00.000  
修订时间：2020-03-30

声明：元征公司对本产品所使用的软件具有完全的知识产权，对于逆向或破解本产品软件的行为，本公司将停用该产品并保留追究其法律责任的权利。



**版权所有！** 未征得深圳元征科技股份有限公司（下称“元征公司”）的书面同意，任何公司或个人不得以任何形式（电子、机械、影印、录制或其它形式）对本说明书进行复制和备份。

本手册专为元征产品的使用而设计，对于将之用于指导其它设备操作而导致的各种后果，本公司不承担任何责任。本手册及其包含的所有范例若有更改，恕不另行通知。

因使用者个人或第三方的意外事故，滥用、误用该设备，擅自更改、修理该设备，或未按元征公司的操作与保养要求而致使设备损坏、遗失所产生的费用及开支等，元征公司及其分支机构不承担任何责任。

对于使用其它选用配件或损耗品而非元征公司原装产品或元征公司认可之产品而导致该设备损坏或出现问题，元征公司不承担任何责任。

正式声明：本说明书所提及之其它产品名称，目的在于说明本设备如何使用，其注册商标所有权仍属原公司。

本设备供专业技术人员或维修人员使用。

## 注册商标

元征公司已在中国及海外若干国家进行了商标注册，其标志为 LAUNCH。在元征公司之商标、服务标志、域名、图标和公司名称还未注册之国家，元征公司声明其对未注册商标、服务标志、域名、图标和公司名称仍享有其所有权。本手册所提及之其它产品及公司名称的商标仍属于原注册公司所有。在未得到拥有人的书面同意之前，任何人不得使用元征公司或所提及的其它公司之商标，服务标志，域名，图标，公司名称。您可以访问车云网网址：<http://www.dbscar.com> 了解元征产品信息；您也可以访问元征网址：<http://www.cnlaunch.com>；或写信至：中国深圳市龙岗区坂雪岗工业区五和大道北元征工业园深圳市元征科技股份有限公司客户服务中心收，与元征公司进行联系，征得其手册使用权之书面同意。

## 重要的安全和操作信息

为了避免人身伤害、财产损失或对产品造成意外损坏，在使用产品前请阅读本节中的全部信息。

### 小心处理设备

请勿掉落、折弯、刺穿、插入异物或在设备上放置重物。内部的易损组件可能会遭到损坏。

### 请勿拆开或改装设备

设备是一个密封装置，内部没有最终用户可维修的部件。必须由授权的维修机构或授权的技术人员进行所有内部维修。尝试拆开或改装设备将使保修无效。

### 请勿尝试更换内部电池

必须由授权的维修机构或授权的技术人员更换内部的充电电池。

## 操作汽车 ECU 注意事项

对装备了电脑控制系统的汽车进行诊断操作时，应注意以下事项：

- 当点火开关接通时，绝不能断开汽车内部电器装置，因为在断开时，由于线圈的自感作用，将会产生很高的瞬时电压，这种电压将会造成传感器及 ECU 的损坏。
- 不能将无线电扬声器等磁性物体置于靠近电脑的地方，因为扬声器的磁铁会损坏 ECU 中的电路和部件。
- 当在汽车上进行焊接作业时，事先应切断 ECU 系统电源。
- 在靠近电脑或传感器的地方进行修理作业时，应倍加注意，以免损坏 ECU 和传感器。
- 在拆装可编程只读存储器时，作业人员应自己搭铁，否则身上的静电会损坏 ECU 电路。
- 除在测试程序中特别说明外，不能用指针型欧姆表测试 ECU 和传感器，而应使用高阻抗的数字仪表进行测试。
- 不要用测试灯去测试那些与 ECU 有关的电器装置，以防止 ECU 或传感器损坏，除非另有说明。
- 当人员进出车厢时，人体的静电放电可产生高达 10000V 的高压，因此对



ECU控制的数字式仪表进行维修作业或靠近这种仪表时，一定要戴上搭铁金属带，将其一端缠在手腕上，另一端夹在车身上。

- 应可靠地连接ECU线束接头，否则可能损坏ECU内部的集成电路等电子元件。

## 目录

<b>一 基本介绍</b> .....	<b>1</b>
1.1 产品简介 .....	1
1.2 组件和控件 .....	2
1.3 性能参数 .....	4
1.4 包装清单 .....	5
<b>二 首次使用</b> .....	<b>9</b>
2.1 充电 .....	9
2.2 连接&开机 .....	9
2.2 主菜单 .....	10
<b>三 传感器</b> .....	<b>12</b>
3.1 如何连接 .....	12
3.2 如何操作 .....	13
3.2.1 直流 DC .....	13
3.2.2 交流 AC .....	18
3.2.3 频率调制 .....	22
<b>四 执行器</b> .....	<b>26</b>
4.1 如何连接 .....	26
4.2 如何操作 .....	27
4.2.1 独立点火模块 (COP) .....	27
4.2.2 怠速马达 .....	29
4.2.3 EGR 控制阀 .....	30
4.2.4 碳罐电磁阀 .....	31
4.2.5 涡轮增压电磁阀 .....	32
4.2.6 喷油嘴 .....	33
4.2.7 VVT 电磁阀 .....	34
4.2.8 电子节气门总成、空调风扇 .....	36

---

<b>五 自定义（手绘）</b> .....	<b>38</b>
5.1 自定义 .....	38
5.2 手绘功能 .....	39
<b>六 正时波形编辑</b> .....	<b>41</b>
<b>七 万用表</b> .....	<b>43</b>
7.1 连接 .....	43
7.2 如何操作 .....	43
7.3 检测示例 .....	44



# 一 基本介绍

## 1.1 产品简介

该模块主要为诊断/模拟传感器故障而专门开发的。其主要包括“传感器”、“执行器”、“自定义（手绘）”和“正时波形编辑”，用户可以方便快捷的对传感器进行诊断与模拟，而传感器是汽车电控系统的信号输入装置，它把汽车各种运行参数，如车速、冷却液温度、发动机转速、空气流量、节气门开度等，转化成电信号输给汽车电脑，汽车电脑根据这些参数来调整发动机的运行状态以保持发动机处于最佳工况。

同时，该模块还支持汽车万用表功能。通过此功能，用户可以进行电压测试、电阻测试和电容测试。该功能与传感器模块使用同一硬件设备。

该模块无法单独使用，必须搭配兼容扩展模块的元征诊断设备同时使用。

## 1.2 组件和控件



图 1-1

序号	名称	说明
1	COM	万用表公共端
2	V/ $\Omega$ /C	万用表测量端
3	电源键	按此按键开/关机。
4	B型USB接口	通过USB连接线与诊断设备连接。
5	电池状态指示灯（绿色）	绿灯常亮表示电量正常；中速闪烁表示电量低（无论红灯是否闪烁）；慢速闪烁表示正在充电。
6	连接状态指示灯（红色）	<ul style="list-style-type: none"> <li>• 红灯常亮表示连接到了诊断设备；红灯闪烁表示连接断开。</li> <li>• 只有当红灯闪烁时才会进入充电状态，充电时绿灯慢速闪烁（如充满则常亮）。</li> </ul>
7	CH2	通道2
8	CH1	通道1
9	7芯针型航空插头接口	用于连接7芯针型航空插头（转6根4mm安全香蕉头线）测量执行器。测量执行器时，需要同时将模块连接至汽车电瓶上给其供电。
10	DC12V电源接口	<p>通过双钳电源线给此模块供电。</p> <p> <b>警告：</b>该接口仅用于在执行“执行器”功能时连接双钳电源线给其供电用。用户不得通过该电源接口给此模块充电。</p>

### 1.3 性能参数

传感器模块：

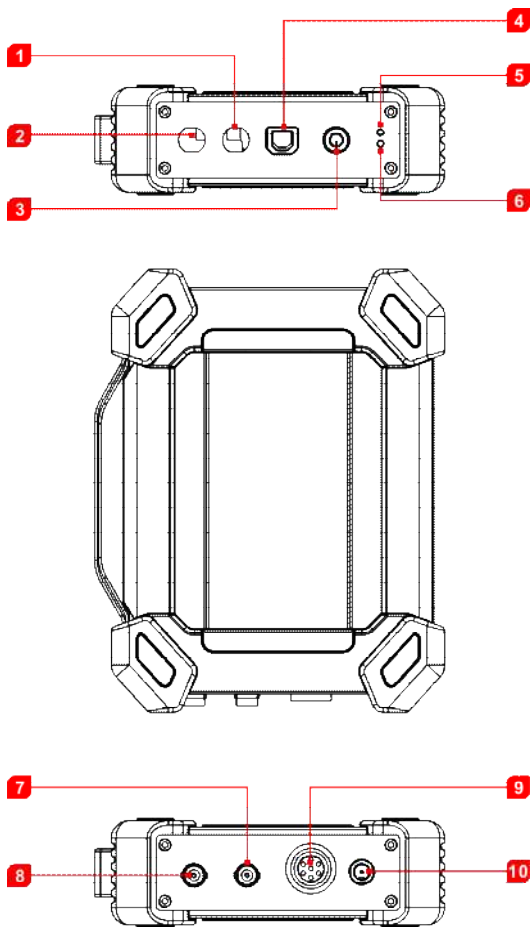
参数	范围
通道数	2
精度	1%
幅度范围	0~20V
最大输出电流	20mA
预定义频率范围	0~10Hz
方波信号脉冲频率	0~15KHz
方波信号占空比	0~100%
电源	模拟器传感器输出/最大电流20mA（输出使用电池供电）
	驱动电磁阀、点火线圈/输出电流2A（外部电源供电）
USB	USB2.0 Type B（带充供电功能/5V）
直流电压模拟	支持
固定频率模拟	支持
预定义波形模拟	支持
手绘波形模拟	支持



信号发生器接口	2个
外部供电口	1个
电磁阀接口	1个
万用表接口	2个
工作温度	-20℃~50℃
存储温度	-30℃~70℃

万用表：

参数	范围
直流电压	0V~700V
交流电压	0V~700V
电阻	0Ω~40MΩ
电容	0F~100uF(最大需要30s的测量时间)
二极管	0V~1.5V
通断检测	低于30Ω时发声





## 1.4 包装清单

传感器模块配件包括传感器测试电缆，探针等。

由于产品配置不同，产品中所包括的配件与本说明书中所列可能有所不同，产品中具体包括的配件请查看产品中所附的装箱单。

以下是各测试线和相关配件外观图：

序号	名称	附图	数量
1	传感器模块		1
2	HT30 测试线	 <p data-bbox="453 637 857 773">用于连接传感器,测试汽车的各种信号的专用线。宽量程的探头,夹子和挂勾能够插进线的末端的4mm的连接器。</p>	2
3	7 芯针型航空头转接线	 <p data-bbox="453 937 857 1030">用于连接传感器模块与执行器进行执行器测试。测试执行器时,必须将传感器模块连接至车辆电瓶上取电。</p>	1
4	双钳电源线	 <p data-bbox="453 1195 857 1292">用于<b>执行器</b>功能模块测试时,从12V电瓶取电、电源孔输入,给传感器模块提供12V电源。</p>	1

5	USB数据线	 <ul style="list-style-type: none"> <li>• 用于连接传感器模块和诊断设备，将传感器模块采集的信号发送给诊断设备进行波形显示。</li> <li>• 配合适配器给传感器模块充电。</li> </ul>	1
6	6路通用引线	 <p>配备的6路引线有3种接头尺寸： 1.0mm，1.6mm和2.8mm。</p> <p>该引线很容易接入现有的汽车线束接口上，方便读取各种传感器的信号。输出信号从引线另一端的4mm香蕉接头通过HT30测试线接入传感器模块的CH1/CH2通道输入口。</p>	3
7	万用表测试笔（黑色+红色）	 <p>在进行万用表功能测试时，需要将其连接至传感器模块的COM和V/<math>\Omega</math>/C端子中。</p>	共2条
8	刺针套装		1

		<p>刺针有很多用途,其细针头可以滑过密封件,以探测连接器。它们有时被称为针刺探针,用于刺穿电线的绝缘层,以便在不损坏电线的情况下进行汽车电气测量。此外,它们还可以用作针尖探针,同时与小电路板工作。</p>	
9	适配器	 <p>配合随机附带的USB线给传感器模块充电。</p>	1

## 二 首次使用

### 2.1 充电

1. 将USB线一端（B型口）插入到传感器模块主机的B型USB端口中，然后将另一端插入到适配器的USB端口中。



图2-1

2. 将适配器插入到电源插座中开始充电。充电时，绿灯会慢速闪烁。充电完成后，绿灯会常亮。

**⚠警告：**请使用随机附带的充电器进行充电，对于使用非本公司指定的其它充电器充电所造成的损坏和损失，本公司一概不承担任何负责。

**🔧**如果电池长期未使用或电池电量耗尽，在充电时可能无法正常开机，这是正常现象。请给电池充电一段时间后，再开机使用。

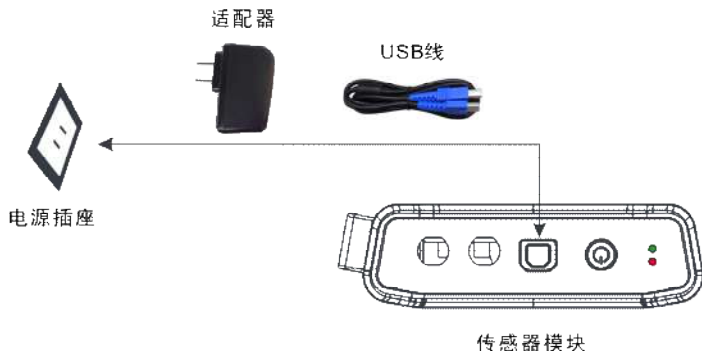
### 2.2 连接&开机

1. 将USB线一端（B型口）插入到传感器模块主机的B型USB端口中，然后将另一端插入到诊断设备的USB端口中。



图2-2

2. 长按【电源】按键3秒以上启动传感器模块。如果电量正常，则绿灯常亮。

指示灯状态说明：

- 
- |    |   |
|----|---|
| 绿灯 | <ul style="list-style-type: none"> <li>• 常亮：表示点亮正常。</li> <li>• 中速闪烁：表示电量低（无论红灯是否闪烁）</li> <li>• 慢速闪烁：表示正在充电中。</li> </ul> |
|----|---|

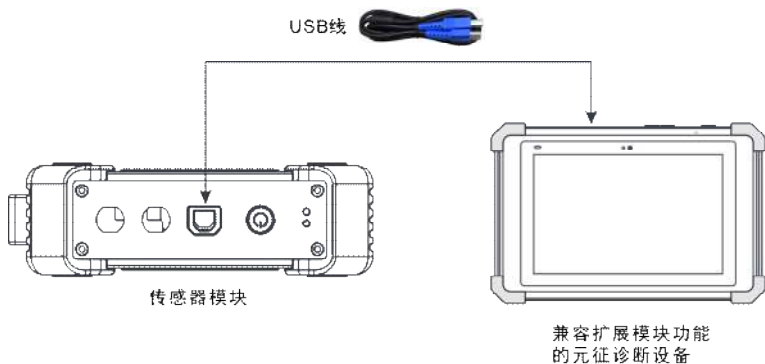
- 
- |    |  |
|----|--|
| 红灯 | <ul style="list-style-type: none"> <li>• 常亮：表示连接到了诊断设备。</li> <li>• 闪烁：表示与诊断设备的连接已断开。</li> </ul> <p>只有当红灯闪烁时才会进入充电状态，充电时绿灯慢速闪烁。</p> |
|----|--|
- 

3. 启动诊断设备并进入到工具箱中，点击【传感器】进入传感器功能主菜单界面。

## 2.2 主菜单

传感器模块主要分为五大功能模块：



图2-3

**传感器：**使用输出电压或波形模拟车载传感器的工作状态，以此准确判断传感器的好坏，减少盲目更换配件。

**执行器：**用于输出 PWM 信号驱动车载线圈类执行器工作。

**自定义(手绘)：**用户可自定义传感器波形，方便用户以后调用进行传感器信号模拟。

**正时波形编辑：**自定义匹配发动机的正时波形(曲轴+凸轮轴)，并同相位输出。

**万用表：**通用万用表的功能。

## 三 传感器

### 3.1 如何连接

传感器模拟功能可以准确判断传感器的好坏，减少盲目更换配件。比如：故障代码显示是水温传感器故障，但是到底是水温传感器本身故障还是传感器到ECU之间的接线故障或是ECU本身故障呢，还需进一步诊断。此时可以通过模拟功能模拟水温传感器的信号代替水温传感器向微机输入信号，如果发动机工作状况改善，故障症状消失，即可判断为水温传感器的故障。若故障症状无改善，可直接在ECU相应端子处将信号输入，若故障症状消失，即为水温传感器至ECU接线故障。若故障症状无改善，则可判定ECU本身故障。

检测传感器时，需要进行如下连接：

- 1) 将传感器模块通过 USB 通讯线连接至诊断设备上（参照第 2.1 章节）。
- 2) 拆下连接在 ECU 上的传感器。
- 3) 根据具体应用和总线端子类型，进行如下连接（**备注**：执行传感器功能时，传感器模块的硬件输出端口为 CH1，CH2）。



图 3-1

- 1) HT30测试线的BNC接头连接至CH1或CH2通道中（根据需要可同时

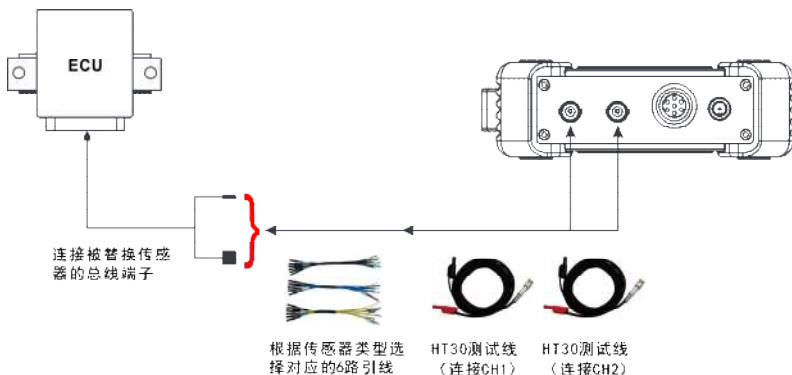

连接CH1和CH2），另一端（分为两路线，红色为信号线，黑色为地线）连接至6路引线任意两路中。

**备注：**连接BNC接头时，注意插入方向，插入后旋转下那个接头以防意外脱落。

- 2) 将连接的那两路引线的另一端（相同颜色）插入到被替换传感器的总线端子中（根据总线端子的公母头类型进行选择）。
- 4) 启动诊断设备并进入相应的传感器模块，在主菜单中点击“传感器”。



图 3-2

## 3.2 如何操作

传感器分三种类别：直流 DC、交流 AC 和频率调制 PFM。

### 3.2.1 直流 DC

**备注：**以下波形图为示例波形图，非实际输出波形图。用户可参考此图改变电压实现功能。

#### 1、水温传感器

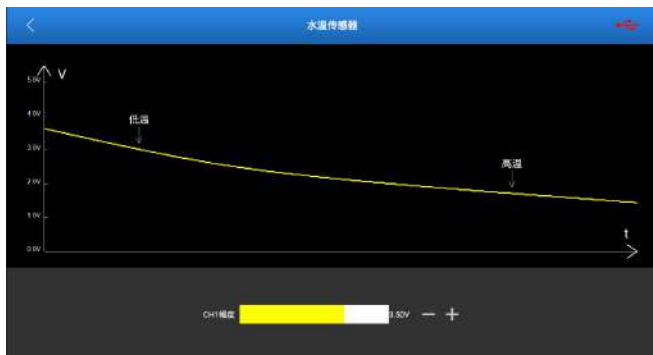

输出端口：CH1

输出类别：直流电压

拖动黄色滑块可改变 CH1 的输出电压值，以此模拟水温的变化。

**备注：**冷车时 3v~5v; 热车后降至 1v; 负温度系数传感器。

一个简单的确认方法为，水温传感器会联动温控风扇，当调节电压值到达一定的阈值时，会启动或停止温控风扇的转动。

## 2、进气温度与进气压力传感器

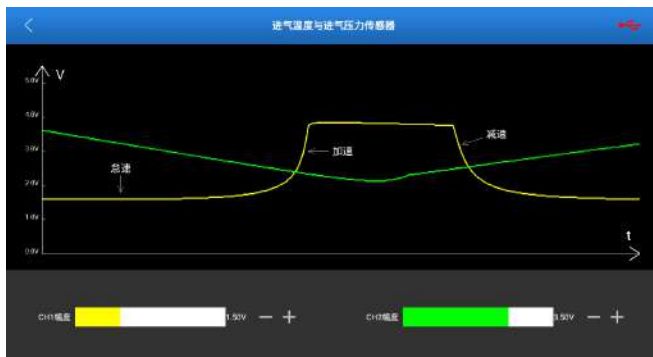

输出端口：CH1, CH2

输出类别：直流电压

CH1: 进气温度



拖动黄色滑块可以改变 CH1 的输出电压值，以此模拟进气温度变化。

CH2: 进气压力



拖动绿色滑块可以改变 CH2 的输出电压值，以此模拟进气压力变化。

### 3、进气压力传感器

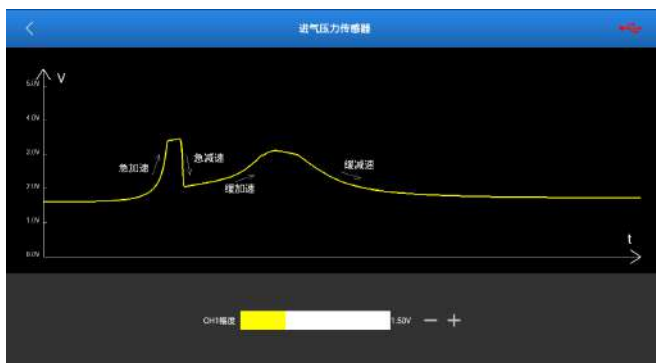

输出端口: CH1

输出类别: 直流电压

拖动黄色滑块可以改变 CH1 的输出电压值，以此模拟进气压力变化。

### 4、节气门位置传感器

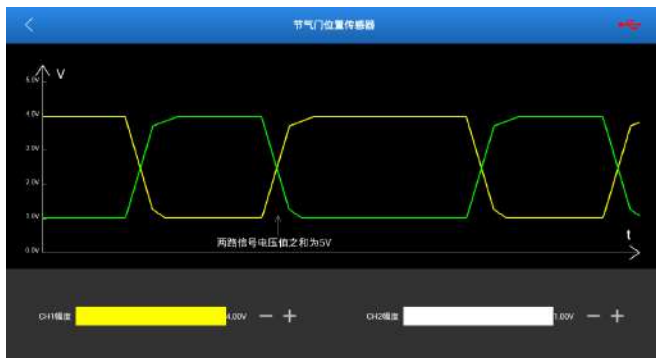

输出端口：CH1，CH2

输出类别：直流电压

拖动黄色滑块可以改变 CH1 的输出电压值；拖动绿色滑块可以改变 CH2 的输出电压值。

**备注：**CH1，CH2 同时输出，且输出电压值的和为 5V，单独调节 CH1 或 CH2 的电压值，都会联动另一个通道。

## 5、油门踏板位置传感器

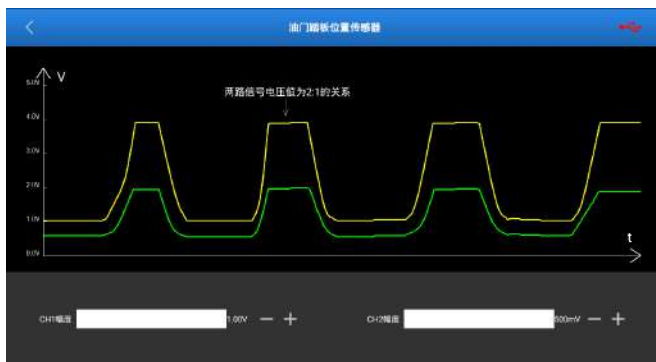

输出端口：CH1，CH2(两个通道任意改变其一，另一个通道都会随之输出相应信号)。

输出类别：直流电压

拖动黄色滑块可以改变 CH1 的输出电压值；拖动绿色滑块可以改变 CH2 的输出电压值。

**备注：**CH1，CH2 同时输出，且 CH1 的输出电压和 CH2 是 2:1 的关系，单独调节 CH1 或 CH2 的电压值，都会联动另一个通道。

## 6、空气流量传感器

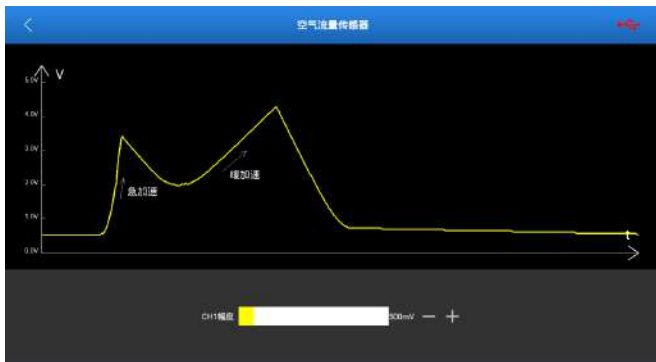

输出端口：CH1

输出类别：直流电压

拖动黄色滑块可以改变 CH1 的输出电压值，模拟空气流量。

## 7、二氧化锆型传感器

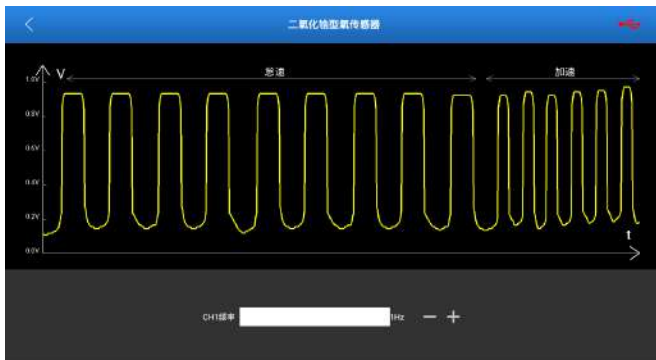

输出端口：CH1

输出类别：类方波

拖动黄色滑块可以改变 CH1 的输出频率，以此模拟加速减速的状态。

## 8、二氧化钛型传感器

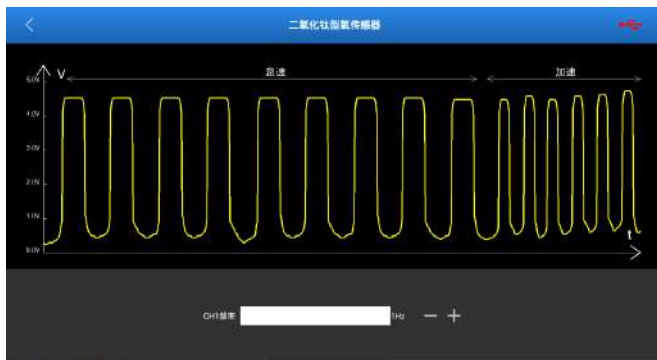

输出端口：CH1

输出类别：类方波

功能实现：拖动黄色滑块可以改变 CH1 的输出频率，以此模拟加速减速的状态。

### 3.2.2 交流 AC

**备注：**以下波形图为例波形图，非实际输出波形图。用户可参考此图改变参数实现功能。

## 1、磁电式曲轴位置传感器

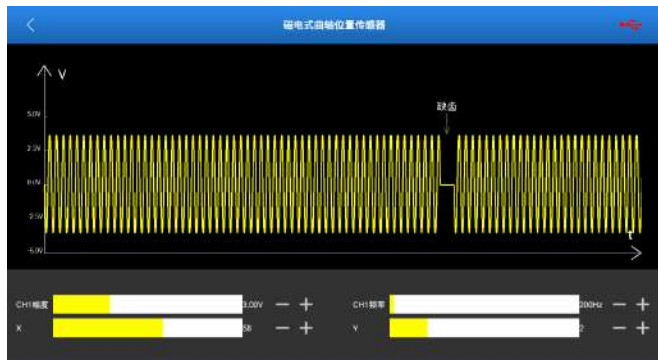

输出端口：CH1

输出类别：类弦波

拖动 CH1 幅度滑块改变输出幅度；拖动 CH1 频率滑块改变输出频率。X 改变弦波 x 的输出数量，Y 改变直线 y 的输出数量。

**备注：**X 表示一次输出多少个弦波，Y 表示输出 X 之后输出多少个直线电压（以 X 弦波的周期为 1）。XY 的数值由实际硬件参数决定。

以 X=8, Y=2 为例，如下图所示：

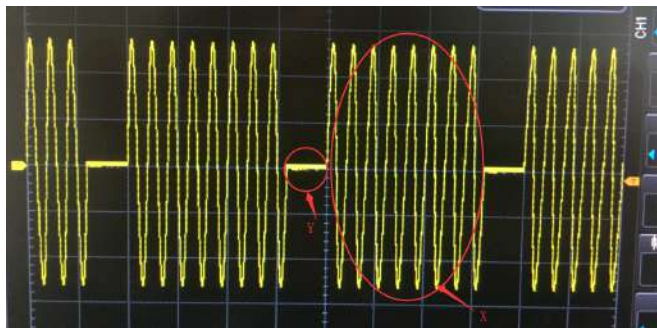

## 2、磁电式凸轮轴位置传感器

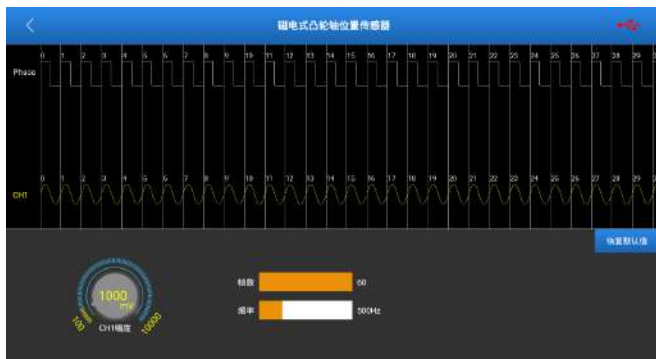

输出端口：CH1

输出类别：类弦波



拖动帧数滑块改变一次输出的总帧数；



拖动频率滑块改变输出频率；



转动旋钮改变幅度值。

**备注：**phase 为时钟，帧数表示一次输出多少时钟对应的波形(如 50 帧就会循环输出 50 个波形)，上方 CH1 对应的波形是可编译的(有正向弦波，反相弦波，直线电压)，用户根据实际情况自行编辑(具体参数由硬件参数决定)。详情参见正时编辑。

### 3、磁电式 ABS 车速传感器



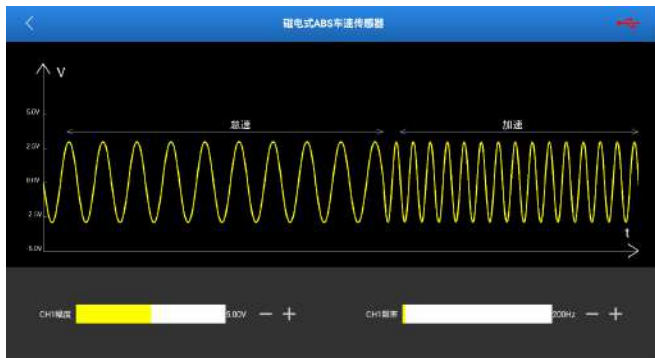

输出端口：CH1

输出类别：类弦波

拖动 CH1 幅度滑块改变输出波形的幅度；拖动 CH1 频率滑块改变输出波形的频率，以此模拟怠速，加速状态。

#### 4、磁电式轮速传感器

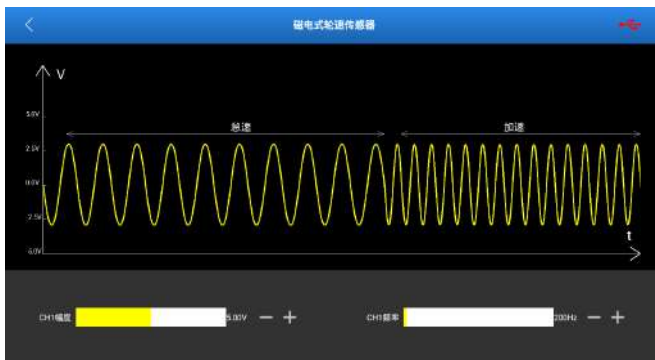

输出端口：CH1

输出类别：类弦波

拖动 CH1 幅度滑块改变输出波形的幅度；拖动 CH1 频率滑块改变输出波形的频率，以此模拟怠速，加速状态。

#### 5、爆震传感器



输出端口：CH1

输出类别：类震荡波

拖动 CH1 幅度滑块改变输出波形的幅度，以此模拟震动的大小；拖动 CH1 频率滑块改变输出波形的频率，以此模拟震动的快慢。

### 3.2.3 频率调制

**备注：**以下波形图为示例波形图，非实际输出波形图。用户可参考此图改变频率实现功能。

#### 1、数字空气流量传感器

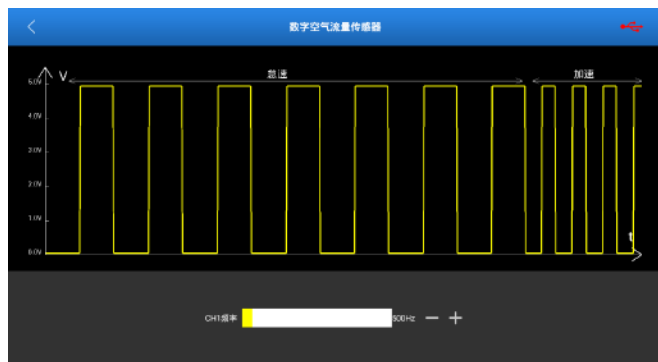

输出端口：CH1

输出类别：类方波

拖动黄色滑块可以改变 CH1 的输出频率，以此模拟加速减速的状态。

## 2、磁阻式 ABS 轮速传感器

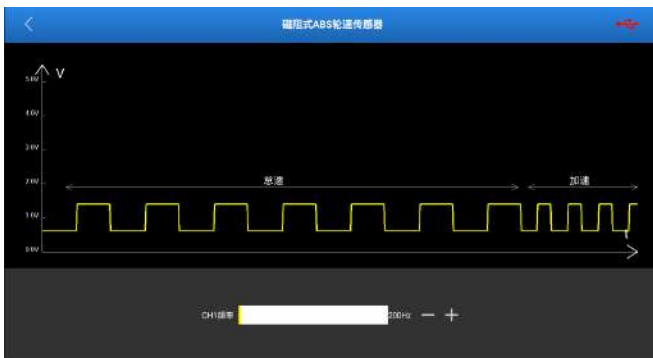

输出端口：CH1

输出类别：类方波

拖动黄色滑块可以改变 CH1 的输出频率，以此模拟加速减速的状态。

## 3、霍尔车速传感器

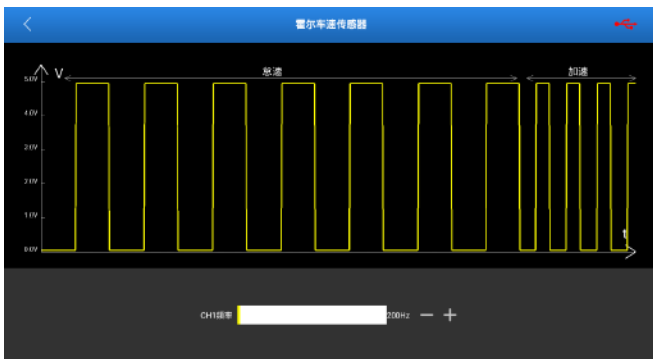

输出端口：CH1

输出类别：类方波

拖动黄色滑块可以改变 CH1 的输出频率，以此模拟加速减速的状态。

## 4、霍尔曲轴传感器

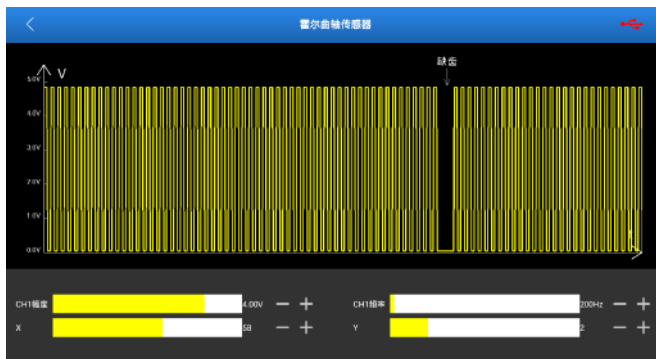

输出端口：CH1

输出类别：类方波



拖动 CH1 幅度滑块改变输出幅度。



拖动 CH1 频率滑块改变输出频率。



X 改变弦波 x 的输出数量，Y 改变直线 y 的输出数量。

**备注：**X 表示一次输出多少个方波，Y 表示输出 X 之后输出多少个直线电压（以 X 方波的周期为 1）。XY 的数值由实际硬件参数决定。

## 5、霍尔凸轮轴传感器

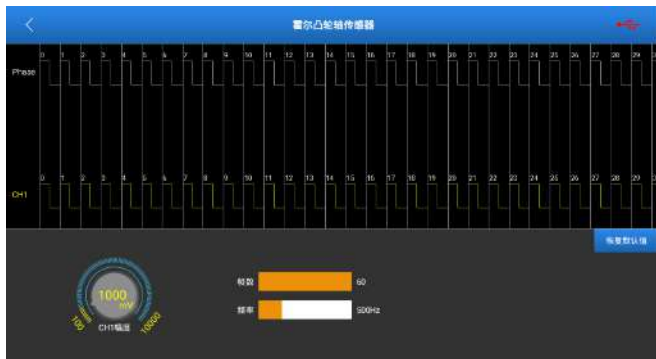

输出端口：CH1

输出类别：类方波



拖动帧数滑块改变一次输出的总帧数；



拖动频率滑块改变输出频率。



转动旋钮改变幅度值。

**备注：**phase 为时钟，帧数表示一次输出多少时钟对应的波形(如 50 帧就会循环输出 50 个波形)，上方 CH1 对应的波形是可编译的(有正向方波，反相方波，直线电压)，用户根据实际情况自行编辑(具体参数由硬件参数决定)。详情参见正时编辑。

## 四 执行器

### 4.1 如何连接

该功能用于输出PWM信号驱动车载线圈类执行器工作，通过查看工作状态以确认执行器的好坏。

检测该功能时，需要进行如下连接：

- 3) 将传感器模块通过 USB 通讯线连接至诊断设备上（参照第 2.1 章节）。
- 4) 根据具体应用和执行器类型，进行如下连接（说明：执行执行器功能时，传感器模块的硬件输出端口为 7 芯针型航空插头接口）。



图 4-1

- 4) 将 7 芯针型航空头转接线一端连接至 7 芯针型航空插头接口中，另一端（分为 6 路安全香蕉头线，每个香蕉头线上有编号，而且有正负端子区分，使用时请注意）根据需要连接至 6 路引线中。

**备注:** 将7芯航空头转接线连接至传感器模块上航空插头接口时，注意两个红点对齐，然后插入即可，插入成功后会听到“滴”的一声。拔出该转接线时，不能直接用力拔。先用手指将标识有红点的卡盖按住，并向外慢慢拔，然后将转接线轻轻拔出。

- 5) 将引线的另一端（相同颜色）插入到执行器对应的插孔中（具体连接方式请参照第4.2章节）。
- 6) 启动诊断设备并进入相应的传感器模块，在主菜单中点击“传感器”。

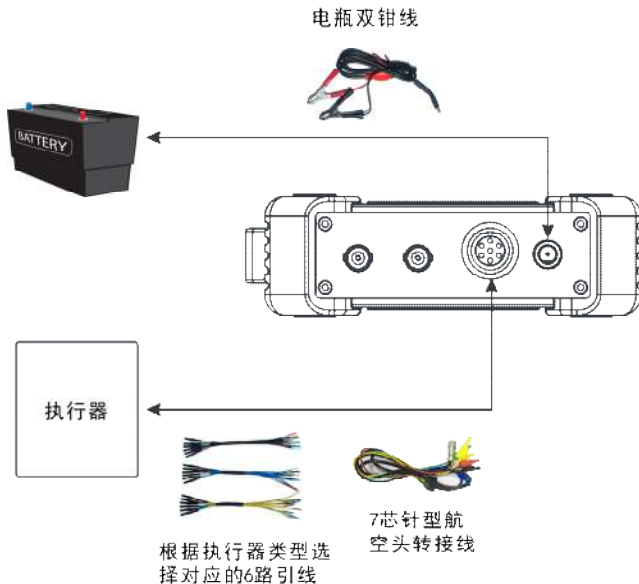

图 4-2

## 4.2 如何操作

执行器有如下分类：独立点火模块、怠速马达、EGR 控制阀、碳罐电磁阀、涡轮增压电磁阀、喷油嘴、VVT 电磁阀、电子节气门总成、空调风扇。

\*说明：执行器的种类并不限于类别中给出的这些，但其工作原理都是一样的，在知晓执行器的工作参数的情况下可以在任何界面下驱动执行器，比如有个未加的执行器 A，其工作参数接近风扇，就可以在电子节气门总成，空调风扇界面下驱动。

**备注:** 以下波形图为示例波形图，非实际输出波形图。

### 4.2.1 独立点火模块（COP）

接线方式：

- 1 线： 电磁阀负
- 2 线： CH1\2 地
- 3 线： 电磁阀正
- 4 线： CH1\2 输出



### 操作方法:

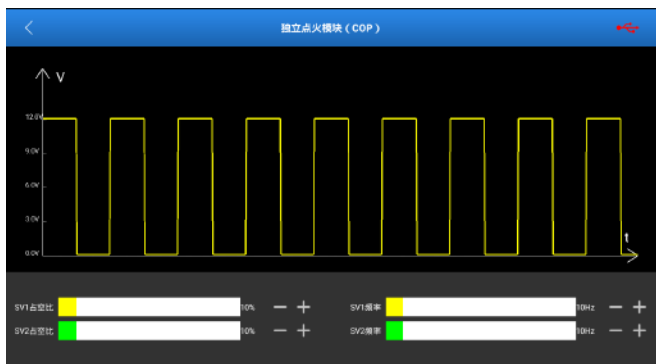

输出端口：电磁阀 1(SV1)、电磁阀 2(SV2)

输出类别：可调占空比方波

拖动 SV1 占空比滑块改变电磁阀 1 的输出占空比；拖动 SV1 频率滑块改变电磁阀 1 的输出频率。

拖动 SV2 占空比滑块改变电磁阀 2 的输出占空比；拖动 SV2 频率滑块改变电磁阀 2 的输出频率。

**备注：**在菜单下将 SV1/SV2 的占空比调至 100%，在自定义中选择对应通道



的波形为方波，频率设置为 10HZ，占空比设置为 10%，幅度为 5V 即可(此独立点火模块为模块型执行器，需要电磁阀口和传感器口同时使用，其他模块型执行器皆可参照)。

#### 4.2.2 怠速马达

接线方式：

- 1 线： 电磁阀 1 正
- 2 线： 电磁阀 2 正
- 3 线： 电磁阀 2 负
- 4 线： 电池阀 1 负

备注：此为线圈型执行器。



操作方法：

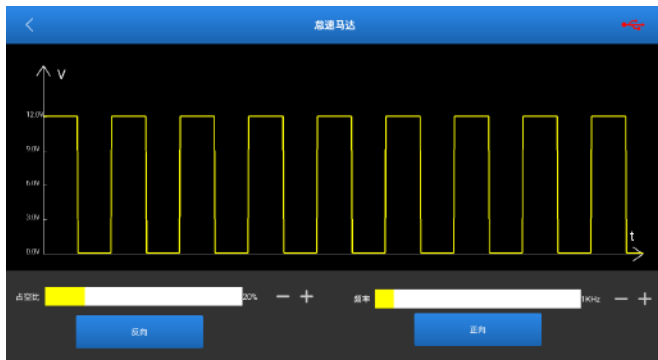

输出端口：电磁阀 1(SV1)、电磁阀 2(SV2)

输出类别：可调占空比方波

拖动占空比滑块改变电磁阀 1, 2 的输出占空比；拖动频率滑块改变电磁阀 1, 2 的输出频率。

【反向】按键步进电机根据硬件连接反向转动一步；【正向】按键步进电机根据硬件连接正向转动一步。

**备注：**修改占空比和频率并不直接驱动步进电机，要点击反向，正向的按键步进电机才会有所有反应(所谓的正反向不是固定的，是根据硬件连接决定的)。

### 4.2.3 EGR 控制阀

接线方式：

1 线：电磁阀 1\2 正

2 线：不连接

3 线：不连接

4 线：不连接

5 线：电磁阀 1\2 负

**备注：**此为线圈型执行器。



操作方法:

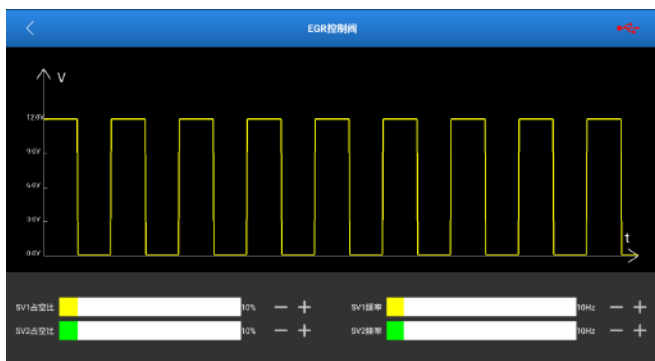

输出端口: 电磁阀 1(SV1)、电磁阀 2(SV2)

输出类别: 可调占空比方波

拖动 SV1 占空比滑块改变电磁阀 1 的输出占空比; 拖动 SV1 频率滑块改变电磁阀 1 的输出频率; 拖动 SV2 占空比滑块改变电磁阀 2 的输出占空比; 拖动 SV2 频率滑块改变电磁阀 2 的输出频率。

#### 4.2.4 碳罐电磁阀

接线方式:

1 线: 电磁阀 1\2 正

2 线: 电磁阀 1\2 负

备注: 此为线圈型执行器。

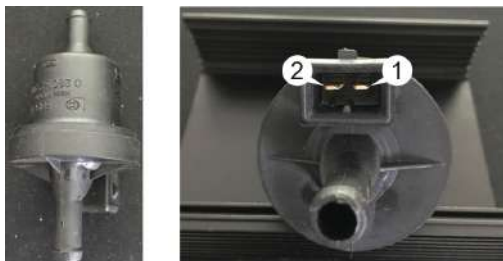

操作方法:

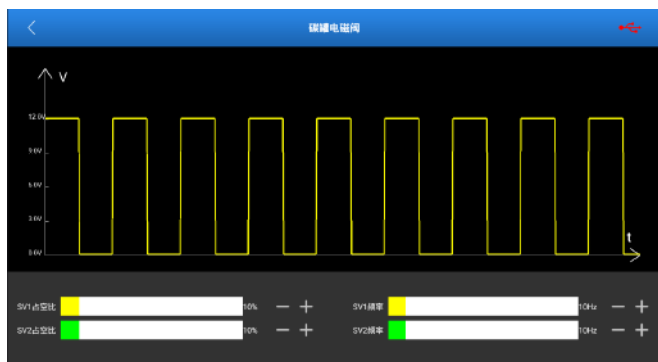

输出端口: 电磁阀 1(SV1)、电磁阀 2(SV2)

输出类别: 可调占空比方波

拖动 SV1 占空比滑块改变电磁阀 1 的输出占空比; 拖动 SV1 频率滑块改变电磁阀 1 的输出频率。

拖动 SV2 占空比滑块改变电磁阀 2 的输出占空比; 拖动 SV2 频率滑块改变电磁阀 2 的输出频率。

#### 4.2.5 涡轮增压电磁阀

接线方式:

1 线: 电磁阀 1\2 正

2 线: 电磁阀 1\2 负

备注: 此为线圈型执行器。

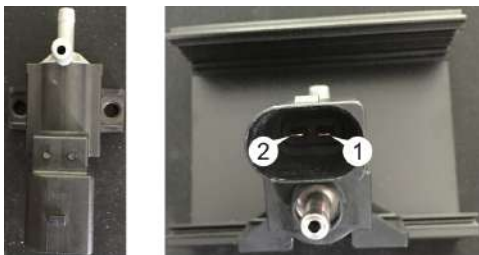

操作方法:

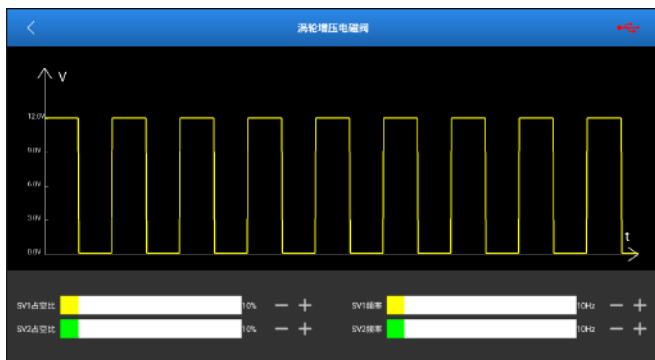

输出端口：电磁阀 1(SV1)、电磁阀 2(SV2)

输出类别：可调占空比方波

拖动 SV1 占空比滑块改变电磁阀 1 的输出占空比；拖动 SV1 频率滑块改变电磁阀 1 的输出频率。

拖动 SV2 占空比滑块改变电磁阀 2 的输出占空比；拖动 SV2 频率滑块改变电磁阀 2 的输出频率。

#### 4.2.6 喷油嘴

接线方式:

1 线：电磁阀 1\2 正

2 线：电磁阀 1\2 负

 备注：此为线圈型执行器。



操作方法:

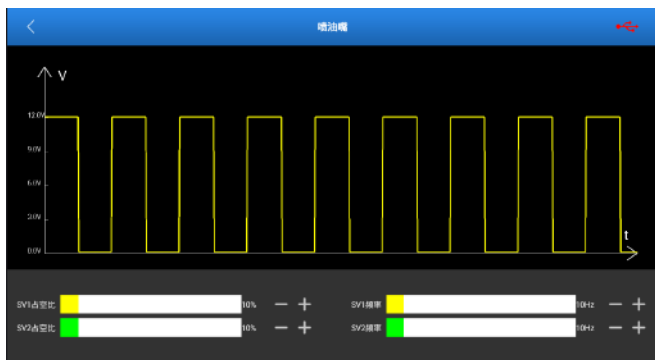

输出端口：电磁阀 1(SV1)、电磁阀 2(SV2)

输出类别：可调占空比方波

拖动 SV1 占空比滑块改变电磁阀 1 的输出占空比；拖动 SV1 频率滑块改变电磁阀 1 的输出频率。

拖动 SV2 占空比滑块改变电磁阀 2 的输出占空比；拖动 SV2 频率滑块改变电磁阀 2 的输出频率。

#### 4.2.7 VVT 电磁阀

接线方式:

凸轮轴排气阀

1 线：电磁阀 1\2 正

2 线：电磁阀 1\2 负

### 凸轮轴进气阀

3 线：电磁阀 1\2 正

4 线：电磁阀 1\2 负

 备注：此为线圈型执行器。



### 操作方法：

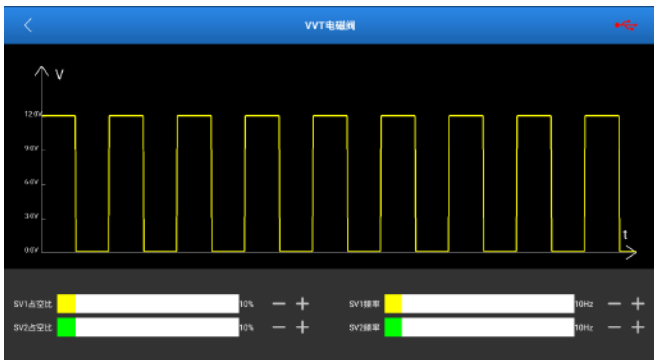

输出端口：电磁阀 1(SV1)、电磁阀 2(SV2)

输出类别：可调占空比方波

拖动 SV1 占空比滑块改变电磁阀 1 的输出占空比；拖动 SV1 频率滑块改变电磁阀 1 的输出频率。

拖动 SV2 占空比滑块改变电磁阀 2 的输出占空比；拖动 SV2 频率滑块改变电磁阀 2 的输出频率。

#### 4.2.8 电子节气门总成、空调风扇

接线方式:

电子节气门总成:

1 线: 电磁阀 1/2 正

2 线: 电磁阀 1/2 负

备注: 此为线圈型执行器。



空调风扇:

1 线: 电磁阀 1/2 正

2 线: 电磁阀 1/2 负

备注: 此为线圈型执行器。



操作方法:



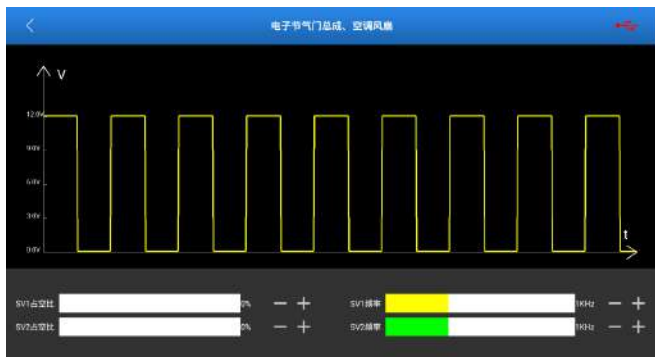

输出端口：电磁阀 1(SV1)、电磁阀 2(SV2)

输出类别：可调占空比方波

拖动 SV1 占空比滑块改变电磁阀 1 的输出占空比；拖动 SV1 频率滑块改变电磁阀 1 的输出频率。

拖动 SV2 占空比滑块改变电磁阀 2 的输出占空比；拖动 SV2 频率滑块改变电磁阀 2 的输出频率。

## 五 自定义（手绘）

自定义就是用户自己操作，没有特别的限制，各种定义好的波形都可以随时切换输出。除了自定义外，还支持手绘，自由度大。

### 5.1 自定义

参照第 3.1 章节连接方法进行连接。

在传感器模块功能主界面点击“自定义（手绘）”进入如下界面。

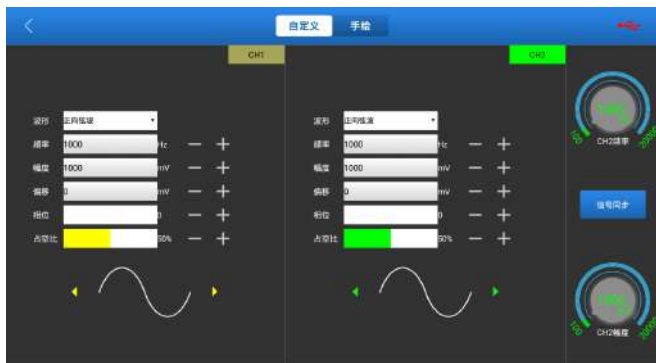

自定义对应的输出通道是 CH1，CH2。

参数可按照如下方法进行设置：

波形：共有 9 中波形可选。正向弦波，反相弦波，正向方波，反向方波，中电压直线，高电压直线，低电压直线，三角波和梯形波。



频率：改变所选波形的频率。



幅度：改变所选波形的幅度。



偏移：改变所选波形的偏移。



相位：改变所选波形的相位。



占空比：改变所选波形的占空比。

【信号】同步按键可以实现 CH1, CH2 两路信号的一键同步(同相位)。

## 5.2 手绘功能

“手绘”功能方便用户模拟比较特殊的波形或故障波。用户只要在上边绘图区绘出需要模拟波形的形状，在参数设置区设置好波形、频率、幅度即可。

点击【手绘】按钮切换至手绘模式。



对应的输出通道是 CH1, CH2。

界面上方的网格为绘制区域，手动选择 CH1, CH2。

参数可按照如下方法进行设置：

总帧数：1-3 可选 表示总的输出点数，一般以个波形由 100 点组成，此 1-3 表述可选由 100, 200, 300 个点来组成一个波形。

编辑帧：可选 1-3 的单个帧进行编辑，也可以选择整体编辑。

波形：可以选择预设波形放入手绘区域。



频率：单个帧的频率，(如果是 3 帧输出，则总的频率为设定频率/3)。



幅度：输出波形的幅度。



偏移：输出波形的偏移。

手绘波形时当手指在边缘抬起时，所绘波形就会自动发出。

## 六 正时波形编辑

该功能用于发动机的正时波形(曲轴+凸轮轴)匹配。

参照第 3.1 章节连接方法进行连接。

在传感器模块功能主界面点击“正时波形编辑”进入如下界面。

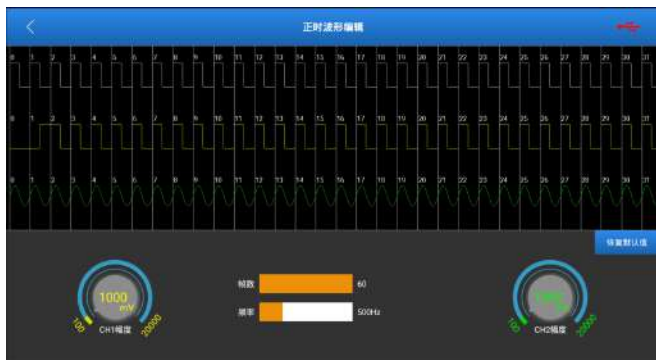

正时编辑对应输出 CH1.CH2。

CH1 模拟凸轮轴信号。

CH2 模拟曲轴信号。

CH1 的每个周期内的波形可调，可选项如下(以 0 周期为例)。

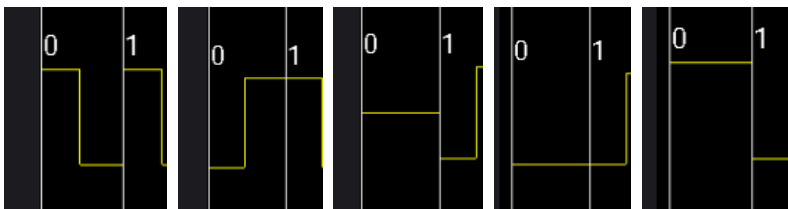

如图所示 0 周期可选 5 个波形。分别是正向方波，反向方波，中直线电平，低直线电平，高直线电平。

CH2 的每个周期内的波形可调，可选项如下(以 0 周期为例)。

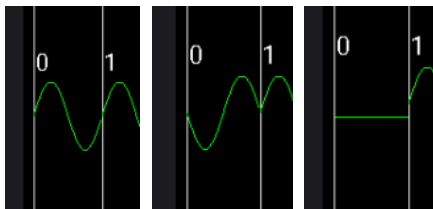

如图所示 0 周期可选 3 个波形，分别是正向弦波，反向弦波，中直线电平。  
具体的 CH1 和 CH2 的波形编辑，要根据不同的发动机来确定。



**帧数：**一次性输出的编辑波形的个数(如 50 帧就是循环输出，一次输出 50 个编译波形)。

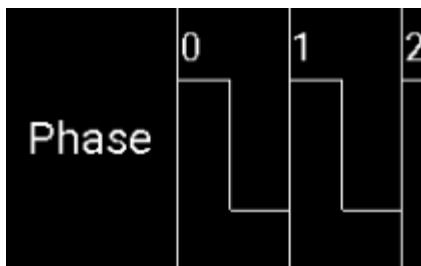

表示 CH1, CH2 对齐周期，在同一个周期内 CH1, CH2 的编辑波形是同相位的。



**频率：** CH1 和 CH2 的频率会同时修改。



**幅度：** CH1 和 CH2 的幅度分别设置。

## 七 万用表

### 7.1 连接

1. 首先给传感器模块上电。
2. 将USB线的B型端子连接至模块的B型接口中，另一端连接至诊断设备的USB接口中。
3. 将万用表测试线（黑色）一端与传感器模块的“COM”接口相连接。
4. 将万用表测试线（红色）一端与传感器模块的“V/ $\Omega$ /C”接口相连接。

### 7.2 如何操作

备注：万用表皆为自动挡，没有手动挡。

在传感器模块功能主界面点击“万用表”进入如下界面。



万用表功能包括：

：直流电压

：交流电压

：通断

：电容



: 电阻

: 二极管

## 7.3 检测示例

### 爆震传感器的检测

#### (1) 爆震传感器电阻的检测

点火开关置于“OFF”位置，拔开爆震传感器导线接头，用“电阻测试”检测爆震传感器的接线端子与外壳间的电阻，应为 $\infty$ （不导通）；若为 $0\Omega$ （导通）则须更换爆震传感器。对于磁致伸缩式爆震传感器，还可应用“电阻测量”检测线圈的电阻，其阻值应符合规定值（具体数据见具体车型维修手册），否则更换爆震传感器。

#### (2) 爆震传感器输出信号的检查

拔开爆震传感器的连接插头，在发动机怠速时用“电压测试”档检查爆震传感器的接线端子与搭铁间的电压，应有脉冲电压输出。如没有，应更换爆震传感器。

### 冷却水温度传感器的检测

#### (1) 冷却水温度传感器的电阻检测

就车检查：点火开关置于OFF位置，拆卸冷却水温度传感器导线连接器，用“电阻测量”，测试传感器两端子间的电阻值。其电阻值与温度的高低成反比（负温度系数），在热机时应小于 $1k\Omega$ 。

单件检查：拔下冷却水温度传感器导线连接器，然后从发动机上拆下传感器；将该传感器置于烧杯内的水中，加热杯中的水，同时用“电阻测量”测量在不同水温条件下水温传感器两接线端子间的电阻值。将测得的值与标准值相比较。如果不符合标准，则应更换水温传感器。

#### (2) 冷却水温度传感器输出信号电压的检测

装好冷却水温度传感器，将此传感器的导线连接器插好，当点火开关置于“ON”位置时，从水温传感器导线连接器两端子间测试传感器输出电压信号。所测得的电压值应随冷却水温成反比变化。当冷却水温度传感器线束断开，点火开关打开时，应为5V左右。



## 保修条款

该保修条款仅适用于通过正常程序购买元征公司产品之用户及经销商。

从交货之日起一年内，元征公司对其电子产品因材料或工艺而造成的缺陷进行保修，因滥用、擅自更改、用于非本产品设计之用途、未按说明书规定的方式操作等导致本设备或部件损坏不在本保修范围内。

## 放弃声明

上述保修条款可以代替其它任何形式的保修条款。

## 订货通知

可更换之零部件和可选配件可直接向元征公司授权的供应商订购，订货时请注明：

- 订购数量；
- 零件编号；
- 零件名称

## 客户服务中心

设备操作过程中遇到任何问题，请致电全国服务热线：**400-066-6666**。

设备需要维修时，请将设备寄至元征公司，并附上购买发票及问题说明。若设备在保修范围之内，元征公司将免费维修；若设备在保修范围之外，元征公司将收费维修并加收回程运费。

元征公司地址：

中国广东省深圳市龙岗区坂雪岗工业区五和大道北元征工业园，深圳市元征科技股份有限公司客户服务中心收 邮编：**518129**

声明：元征公司保留更改产品设计与规格的权利，届时恕不另行通知。实物外观与颜色可能与说明书中显示的有差别，请以实物为准。我们已尽最大努力力求使书中所有描述准确，但仍难免有不妥之处，如有疑问，请联系经销商或元征售后服务中心，本公司不承担任何因误解而产生的后果。